



**CREATING FUTURE.**

**INNOVATING SOLUTIONS.**



**CEASEFIRE FLAGSHIP  
FIREFIGHTING TECHNOLOGIES**

# CEASEFIRE TODAY

## CREATING GLOBAL QUALITY BENCHMARKS

Ceasefire today is a fast-emerging global fire safety brand that protects millions across the globe. The company is one of the rarest in the world to have such a diverse firefighting product portfolio as a part of one ecosystem.

A leading manufacturer of world certified Fire Extinguishers, Specialised Suppression Systems for High-Risk Enclosed Spaces, Kitchen Suppression Systems, Accessories and more, that are manufactured at the company's world-class production facility in India, the company is setting global benchmarks in quality, safety and performance.



Ceasefire fire solutions today conform to the highest quality standards in the world and are certified by top-notch global agencies like BS EN3, BS EN1866, LPCB, BSI, UL, EU-MED, PED, VDS, UKCA-MER, UKCA-PED, FM GLOBAL and ISO 9001.

Ceasefire today is a proud team of over 2000 people based at company offices in India and the United Kingdom and works with approx 1000 trade partners in India, over 150 in the UK and 50+ worldwide, acquiring over 3000 new customers each month and selling a fire product every 61 seconds.

### 360-degree Integrated Firefighting Portfolio



KM666994



BS EN 3  
LPCB Cert ref. 1329b



2831



1128



0832 / 2022

UK  
CA



VdS

# CEASEFIRE UK

## CREATING FUTURE. INNOVATING SOLUTIONS.

At the heart of the Ceasefire ecosystem is innovation and the desire to find solutions to address fire risk in new emerging spaces of the fast-evolving world. Every Ceasefire product is created to solve a unique problem in the area of firefighting.



Be it our green fire extinguishers paving the way to a greener and sustainable future, our speciality range of firefighters that are designed considering the most practical and real-life scenarios, specialised systems to protect high-risk enclosed spaces or our world-class kitchen fire fighting range that is made to combat the most challenging cooking oil fires, at Ceasefire we are setting quality standards in fire safety every day.



# CONTENTS

## Automatic Fire Solutions

Automatic M-Series Extinguishers .....	06
Introduction	
Wall Mounted Automatic M-series Extinguishers	
Ceiling Mounted Automatic M-series Extinguishers	
Creating An Integrated Total Flooding System using M-Series Extinguishers	
Launcher (Extinguisher + Modular Suppression System) .....	27
Mini Pro (Micro-Environment Fire Suppression System) .....	32

## Ceasefire Next

MultiMax L-ion Portable Extinguishers .....	41
Fluorine Free Foam Portable Extinguishers .....	50
Green Max Portable Extinguishers .....	55
Clean Agent FK Based Portable Extinguishers .....	58
Water Spray Portable Extinguishers .....	63
Foam Spray Portable Extinguishers .....	66
Wet Chemical Spray Portable Extinguishers .....	69

## Watermist Extinguishers

Watermist Portable Extinguishers .....	75
Foam mist Portable Extinguishers .....	78
Action-Pac (Portable Watermist & Foam mist) .....	81
CAFS (Watermist Compressed Air Foam System - Low Pressure) .....	84
Quad (Watermist & Foam mist Wheeled Extinguishers) .....	88
Tetraquad .....	96



## Ceasefire Classics

Home And Car Extinguishers .....	102
ABC Powder Portable & Wheeled Extinguishers .....	103
CO <sub>2</sub> Portable & Wheeled Extinguishers .....	103
Water Portable & Wheeled Extinguishers .....	104
Foam Portable & Wheeled Extinguishers .....	105
Wet Chemical Portable Extinguishers .....	105
B Plus (Class B) Extinguishers .....	106
Metal Fire Extinguishers .....	106

## Ceasefire Accessories

Strolleys .....	108
Flat Pack Tubular Stand- Chrome Finish .....	109
Signages .....	111
Flat Pack Trolleys .....	115
Flat Pack Fire Extinguisher Stand .....	117
Modular Plastic Stands .....	117
Specially Designed Mounting Bracket .....	118





# AUTOMATIC FIRE SOLUTIONS

24x7 AUTOMATED FIRE PROTECTION

FEATURING

# AUTOMATIC M-SERIES EXTINGUISHERS

## INTRODUCTION

The Ceasefire M Series Automatic extinguishers is a breakthrough range of Wall Mounted and Ceiling Mounted units that are designed for three-fold fire protection of a premises that is Intuitive (Self Activated), Responsive (Monitorable) and Scalable (Expandable).

Mounted and Ceiling Mounted variants and are designed to give 24x7 automatic fire protection to any space where human presence is low or absent and manual fire detection and fire fighting is a challenge.

The modular nature of these extinguishers make them retrofittable and can instantly be mounted in a variety of spaces, making the premises self-reliant on fire safety, without having to undertake any structural changes in the space.

The biggest strength of the Ceasefire M Series Extinguishers however is their ability to become monitorable and scalable. By opting for a Pressure Switch these extinguishers can be integrated to third-party devices to become monitorable. On the other hand these extinguishers can also be used as building blocks to form a scalable and integrated total flooding system by opting for Metron Actuators and connecting the units with fire detection devices and a control panel.



## Making the M Series Automatic Extinguishers Monitorable

With the presence of a pressure port in these extinguisher units, these can be made monitorable by opting for a Pressure Switch and can be integrated to any third-party device such as a Fire Alarm Panel, a stand-alone Siren Strobe or a Building Management System for monitoring purpose. This enables users to not only get an alert on activation of these units in case of fire but also do preventive-maintenance monitoring of the units.



**In-built Pressure Port**



**Optional Pressure Switch**



## Scaling up to a Total Flooding System

The Ceasefire M Series extinguishers can be used as building blocks to form an integrated total flooding system by opting for Metron Actuators which can be further connected with a network of detectors via a control panel to form a formidable fire suppression system.

# WALL MOUNTED AUTOMATIC M-SERIES EXTINGUISHERS

This innovative extinguisher functions as a standalone system. With simple wall-mount brackets, installation is quick and seamless. The telescopic arm (optional) further ensures precise coverage of hard-to-reach fire risk zones, offering an ideal solution for challenging installations while saving valuable floor space.



*Available in Clean agent Fluoroketone (FK-5-1-12) and ABC Dry powder MAP50.*

These wall-mounted automatic M Series extinguishers come equipped with a pressure monitoring port and by opting for a Pressure Switch these can be made monitorable by integrating it with third party devices such as BMS, Fire alarm systems, or Stand alone Sirens with/without beacon.





## FEATURES & BENEFITS OF WALL MOUNTED M-SERIES EXTINGUISHERS



### Easy To Install

Retrofittable system and can be installed with least amount of structural changes in a premises.



### Saves Space

Agent cylinders are wall mounted units that do not require any floor space.



### Automatic Actuation

Detects fire through thermal sensor and activates automatically.



### Extinguishing Agents

Available in ABC Powder and Clean agent Fluoroketone (FK-5-1-12).



### Targeted Protection

Option flexible mounting bracket that enables optimal positioning of the extinguisher in the risk zone proving targeted protection.



### Container Sizes

These wall mounted units are available in 1kg, 2kg, 4kg, 6kg and 9kg variants to suit diverse kinds of premises and applications.



### Electrical Actuation Option

The units can be activated electrically by opting for metron actuators and connecting them to a network of detectors via a control panel to be configured as a Total Flooding System.



### Monitorable Option

These automatic extinguishers can be upgraded to become monitorable by opting for a pressure switch and integrating it with third-party devices.



### Certification

CE marked and UKCA approved.



### Secure Mounting Bracket

Comes with a secure mounting bracket for direct installation on the wall.

Scan the QR code  
to know more  
about the product



Fluoroketone Extinguishers (FK-5-1-12)



ABC Powder Extinguishers (MAP 90)

# TECHNICAL SPECIFICATIONS

## WALL MOUNTED AUTOMATIC M-SERIES (ABC POWDER MAP50)

Nomenclature	Fire Ext. Automatic M Wall Mounted 1Kg MS SP Red	Fire Ext. Automatic M Wall Mounted 2Kg MS SP Red	Fire Ext. Automatic M Wall Mounted 4Kg MS SP Red	Fire Ext. Automatic M Wall Mounted 6Kg MS SP Red	Fire Ext. Automatic M Wall Mounted 9Kg MS SP Red
Stored Pressure / Cartridge	Stored Pressure	Stored Pressure	Stored Pressure	Stored Pressure	Stored Pressure
Agent	ABC Powder MAP50	ABC Powder MAP50	ABC Powder MAP50	ABC Powder MAP50	ABC Powder MAP50
Product Code	CF-001401C	CF-001402C	CF-001403C	CF-001404C	CF-001405C
Certification Standards	PED	PED	PED	PED	PED
CE	Yes	Yes	Yes	Yes	Yes
UKCA	Yes	Yes	Yes	Yes	Yes
Gross Weight (approx.)	1.90 Kg	4.05 Kg	7.15 Kg	9.50 Kg	13.95 Kg
Net Contents (approx.)	1 Kg	2 Kg	4 Kg	6 Kg	9 Kg
Approx. Height Of Fire Ext.	370 mm	442 mm	493 mm	538 mm	668 mm
Type of Operating Mechanism	Automatic Thermal Quarzoid Bulb and Elect (metron)		Automatic Thermal Quarzoid Bulb and Elect (metron)		
Discharge Time (approx.)	1 sec	1.2 sec	2.5 sec	3.5 sec	5 sec
Maximum Spacing Allowed	1.2 m	1.4 m	3 m	4 m	5 m
Effective Coverage Area	1.5 m <sup>2</sup>	3 m <sup>2</sup>	9 m <sup>2</sup>	12 m <sup>2</sup>	20 m <sup>2</sup>
Maximum Ceiling Height	0.8 m	1.4 m	2.5 m	3 m	3.5 m
Actuation Temperature*	79°C ± 4°C	79°C ± 4°C	79°C ± 4°C	79°C ± 4°C	79°C ± 4°C
Type of Discharge Fitting	Sprinkler With Quartzoid Bulbhead	Sprinkler With Quartzoid Bulbhead	Sprinkler With Quartzoid Bulbhead	Sprinkler With Quartzoid Bulbhead	Sprinkler With Quartzoid Bulbhead
Warranty In Years	5	5	5	5	5
Working Pressure	15 Bar	15 Bar	15 Bar	15 Bar	15 Bar
Dia. Of Shell (OD)	86 mm	108 mm	140 mm	160 mm	175 mm
Operating Temperature	-30°C to 60°C	-30°C to 60°C	-30°C to 60°C	-30°C to 60°C	-30°C to 60°C
Hydrostatic Test Pressure	30 Bar	30 Bar	30 Bar	30 Bar	30 Bar
Body Thickness	1.4 mm	1.4 mm	1.2 mm	1.4 mm	1.4 mm

\*Quartzoid bulb in alternate temperature settings as mentioned below are available on request and would be dependent on MOQ for your region. Please check the availability and delivery time before ordering.

### QUARTZOID BULB KEY\*

● 57°C / 135°F

● 68°C / 155°F

● 79°C / 174°F

● 93°C / 200°F

● 141°C / 286°F

## WALL MOUNTED AUTOMATIC M-SERIES (FK-5-1-12)

Nomenclature	Fire Ext. Automatic M Wall Mounted 1Kg MS SP Red	Fire Ext. Automatic M Wall Mounted 2Kg MS SP Red	Fire Ext. Automatic M Wall Mounted 4Kg MS SP Red	Fire Ext. Automatic M Wall Mounted 6Kg MS SP Red	Fire Ext. Automatic M Wall Mounted 9Kg MS SP Red
Stored Pressure / Cartridge	Stored Pressure	Stored Pressure	Stored Pressure	Stored Pressure	Stored Pressure
Agent	FK-5-1-12	FK-5-1-12	FK-5-1-12	FK-5-1-12	FK-5-1-12
Product Code	CF-001411C	CF-001413C	CF-001415C	CF-001416C	CF-001417C
Certification Standards	PED	PED	PED	PED	PED
CE	Yes	Yes	Yes	Yes	Yes
UKCA	Yes	Yes	Yes	Yes	Yes
Gross Weight (approx.)	1.85 Kg	3.35 Kg	6.05 Kg	8.75 Kg	12.95 Kg
Net Contents (approx.)	1 Kg	2 Kg	4 Kg	6 Kg	9 Kg
Approx. Height Of Fire Ext.	370 mm	442 mm	493 mm	538 mm	668 mm
Type of Operating Mechanism	Automatic Thermal Quartzoid Bulb and Elect (metron)		Automatic Thermal Quartzoid Bulb and Elect (metron)		
Min. Discharge Time	0.5 sec	1 sec	2 sec	3 sec	4 sec
Min. Single Volume Coverage	0.79 m <sup>3</sup>	1.58 m <sup>3</sup>	3.16 m <sup>3</sup>	4.74 m <sup>3</sup>	7.11 m <sup>3</sup>
Max. Single Volume Coverage	1.4 m <sup>3</sup>	2.8 m <sup>3</sup>	5.7 m <sup>3</sup>	8.5 m <sup>3</sup>	12.8 m <sup>3</sup>
Concentration At Max. Volume	4.5 v/kg %	4.5 v/kg %	4.5 v/kg %	4.5 v/kg %	4.5 v/kg %
Actuation Temperature*	79°C ± 4°C	79°C ± 4°C	79°C ± 4°C	79°C ± 4°C	79°C ± 4°C
Type of Discharge Fitting	Sprinkler With Quartzoid Bulbhead	Sprinkler With Quartzoid Bulbhead	Sprinkler With Quartzoid Bulbhead	Sprinkler With Quartzoid Bulbhead	Sprinkler With Quartzoid Bulbhead
Warranty In Years	5	5	5	5	5
Working Pressure	10 Bar	10 Bar	10 Bar	10 Bar	10 Bar
Dia. Of Shell (OD)	86 mm	108 mm	140 mm	160 mm	175 mm
Operating Temperature	-30°C to 60°C	-30°C to 60°C	-30°C to 60°C	-30°C to 60°C	-30°C to 60°C
Hydrostatic Test Pressure	30 Bar	30 Bar	30 Bar	30 Bar	30 Bar
Body Thickness	1.4 mm	1.4 mm	1.2 mm	1.4 mm	1.4 mm

\*Quartzoid bulb in alternate temperature settings as mentioned below are available on request and would be dependent on MOQ for your region. Please check the availability and delivery time before ordering.

### QUARTZOID BULB KEY\*

● 57°C / 135°F

● 68°C / 155°F

● 79°C / 174°F

● 93°C / 200°F

● 141°C / 286°F

# CEILING MOUNTED AUTOMATIC M-SERIES EXTINGUISHERS

Ceasefire Ceiling Mounted Automatic M Series Extinguishers are self-contained units with thermal sensors that detect the rise in the temperature of the area and activate automatically, even when there is no one present, ensuring that the fire is brought under control early and efficiently.

A key benefit of these units is that they not only bring automated protection for places with low human traffic, but being ceiling mounted they also save productive floor space of any premises in a big way.



*Available in Clean agent (Fluoroketone (FK-5-1-12), and ABC Dry powder MAP90.*

The Ceiling Mounted Automatic M Series extinguishers come equipped with a pressure monitoring port and by opting for a Pressure Switch these can be made monitorable by integrating it with third party devices such as BMS, Fire alarm systems, or Stand alone Sirens with/without beacon.





## FEATURES & BENEFITS OF CEILING MOUNTED M-SERIES EXTINGUISHERS



### Automatic actuation

Detects fire through thermal sensor and activates automatically.



### Tamper Proof Design

Being ceiling mounted the extinguisher is tamper proof.



### Easy To Install

Retrofittable and can be installed with least amount of structural changes in a premises.



### Requires Minimal Fittings

Does not require an extensive network of pipes, fittings and ducts for installation.



### Highly Cost Effective

Does not require extensive fitments it works out to be price competitive.



### Saves Space

Agent cylinders are ceiling mounted units that do not require any floor space.



### Monitorable Option

These automatic extinguishers can be upgraded to become monitorable by opting for a pressure switch and integrating it with third-party devices.



### Electrical Actuation Option

The units can be activated electrically by opting for metron actuators and connecting them to a network of detectors via a control panel to be configured as a Total Flooding System.



### Extinguishing Agents

Available in ABC Powder and Clean extinguishing agent Fluoroketone (Fk-5-1-12).



### Container Sizes

These ceiling mounted units are available in 2kg, 5kg, 10kg and 15kg variants to suit diverse kinds of premises.



### Certification

BSI tested, CE marked and UKCA approved.

Scan the QR code  
to know more  
about the product



Fluoroketone Extinguishers (FK-5-1-12)



ABC Powder Extinguishers (MAP 90)

\*The pressure switch shown in the picture of Ceiling Mounted M-Series Extinguishers above is for representation purposes only. It is an optional device and is not a part of the standard products.

# TECHNICAL SPECIFICATIONS

## CEILING MOUNTED AUTOMATIC M-SERIES (ABC POWDER MAP90)





Nomenclature	Fire Ext. Automatic M Ceiling Mounted 2Kg MS SP Red	Fire Ext. Automatic M Ceiling Mounted 5Kg MS SP Red	Fire Ext. Automatic M Ceiling Mounted 10Kg MS SP Red	Fire Ext. Automatic M Ceiling Mounted 15Kg MS SP Red
Stored Pressure / Cartridge	Stored Pressure	Stored Pressure	Stored Pressure	Stored Pressure
Agent	ABC Powder MAP90	ABC Powder MAP90	ABC Powder MAP90	ABC Powder MAP90
Product Code	CF-001388B	CF-000017B	CF-000018B	CF-001490B
Certification Standards	PED	PED	PED	PED
CE	Yes	Yes	Yes	Yes
UKCA	Yes	Yes	Yes	Yes
BSI Tested*	Yes**	Yes	Yes	Yes**
Gross Weight (approx.)	3.97 Kg	8.87 Kg	15.95 Kg	20.70 Kg
Net Contents (approx.)	2 Kg	5 Kg	10 Kg	15 Kg
Approx. Height Of Fire Ext.	287 mm	367 mm	389 mm	469 mm
Type of Operating Mechanism	Automatic Thermal Quarzoid Bulb and Elect (metron)		Automatic Thermal Quarzoid Bulb and Elect (metron)	
Min. Discharge Time	2 to 5 sec	4 to 8 sec	6 to 10 sec	12 to 18 sec
Maximum Spacing Allowed	2.3 m	2.8 m	5.5 m	6.5 m
Effective Coverage Area	5 m <sup>2</sup>	12.5 m <sup>2</sup>	25 m <sup>2</sup>	37.5 m <sup>2</sup>
Maximum Ceiling Height	1.5 m	3 m	3.5 m	4 m
Actuation Temperature***	68°C ± 4°C	68°C ± 4°C	68°C ± 4°C	68°C ± 4°C
Type of Discharge Fitting	Sprinkler With Quartzoid Bulbhead		Sprinkler With Quartzoid Bulbhead	
Warranty In Years	5	5	5	5
Working Pressure	15 Bar	15 Bar	15 Bar	15 Bar
Dia. Of Shell (OD)	175 mm	240 mm	300 mm	300 mm
Operating Temperature	-30°C to 60°C	-30°C to 60°C	-30°C to 60°C	-30°C to 60°C
Hydrostatic Test Pressure	35 Bar	35 Bar	35 Bar	35 Bar
Body Thickness	2 mm	1.6 mm	2 mm	2 mm

\*Certificate awaited.

\*\*Co-related from coverage defined for same sizes and agent types verified in Atom X BSI certification.

\*\*\*Quartzoid bulb in alternate temperature settings as mentioned below are available on request and would be dependent on MOQ for your region. Please check the availability and delivery time before ordering.

### QUARTZOID BULB KEY \*\*\*

 57°C / 135°F	 68°C / 155°F	 79°C / 174°F	 93°C / 200°F	 141°C / 286°F
---	--	--	---	---

## CEILING MOUNTED AUTOMATIC M-SERIES (FK-5-1-12)

Nomenclature	Fire Ext. Automatic M Ceiling Mounted 2Kg MS SP Red	Fire Ext. Automatic M Ceiling Mounted 5Kg MS SP Red	Fire Ext. Automatic M Ceiling Mounted 10Kg MS SP Red	Fire Ext. Automatic M Ceiling Mounted 15Kg MS SP Red
Stored Pressure / Cartridge	Stored Pressure	Stored Pressure	Stored Pressure	Stored Pressure
Agent	FK-5-1-12	FK-5-1-12	FK-5-1-12	FK-5-1-12
Product Code	CF-001393B	CF-001337B	CF-001338B	CF-001493B
Certification Standards	PED	PED	PED	PED
CE	Yes	Yes	Yes	Yes
UKCA	Yes	Yes	Yes	Yes
BSI Tested*	Yes	Yes	Yes	Yes
Gross Weight (approx.)	4.00 Kg	7.50 Kg	14.35 Kg	18.60 Kg
Net Contents (approx.)	2 Kg	5 Kg	10 Kg	15 Kg
Approx. Height Of Fire Ext.	287 mm	367 mm	389 mm	469 mm
Type of Operating Mechanism	Automatic Thermal Quarzoid Bulb and Elect (metron)		Automatic Thermal Quarzoid Bulb and Elect (metron)	
Min. Discharge Time	2 to 5 sec	4 to 8 sec	6 to 10 sec	6 to 15 sec
Min Single Volume Coverage	1.58 m <sup>3</sup>	3.95 m <sup>3</sup>	7.9 m <sup>3</sup>	11.85 m <sup>3</sup>
Max Single Volume Coverage	2.8 m <sup>3</sup>	7.2 m <sup>3</sup>	14.4 m <sup>3</sup>	21.5 m <sup>3</sup>
Concentration At Max Volume	4.5 v/kg %	4.5 v/kg %	4.5 v/kg %	4.5 v/kg %
Actuation Temperature**	68°C ± 4°C	68°C ± 4°C	68°C ± 4°C	68°C ± 4°C
Type of Discharge Fitting	Sprinkler With Quartzoid Bulbhead		Sprinkler With Quartzoid Bulbhead	
Warranty In Years	5	5	5	5
Working Pressure	10 Bar	10 Bar	10 Bar	10 Bar
Dia. Of Shell (OD)	86 mm	108 mm	160 mm	160 mm
Operating Temperature	-30°C to 60°C	-30°C to 60°C	-30°C to 60°C	-30°C to 60°C
Hydrostatic Test Pressure	35 Bar	35 Bar	35 Bar	35 Bar
Body Thickness	2 mm	1.6 mm	2 mm	2 mm

\*Certificate awaited.

\*\*Quartzoid bulb in alternate temperature settings as mentioned below are available on request and would be dependent on MOQ for your region. Please check the availability and delivery time before ordering.

### QUARTZOID BULB KEY \*\*

● 57°C / 135°F

● 68°C / 155°F

● 79°C / 174°F

● 93°C / 200°F

● 141°C / 286°F

# CREATING AN INTEGRATED TOTAL FLOODING SYSTEM

The Ceasefire M Series extinguishers can be used as building blocks to form an integrated total flooding system by opting for Metron Actuators.

The user needs to opt for Metron Actuators to be installed at the Nozzle heads of the M Series extinguishers which can be further connected with a network of detectors via a control panel to form a formidable fire suppression system.

The detection module of the system can be configured using a wide variety of detectors such as smoke detectors, beam detectors, heat detectors, or others depending upon the need of the premises and all interact with a central control panel.

The system acts on the principle of cross-zoning. Only when two or more detectors from two separate zones confirm the fire episode to the control panel, the panel sends an activation signal to the system. The activation signal is sent to the Metron Actuator in the form of an electrical impulse. On receiving this electrical impulse a metal pin is fired inside the actuator that breaks the glass vial placed at the discharge point of extinguishing units, triggering the discharge of the agent. What makes such a system configuration truly versatile is that all fire suppression system units are triggered simultaneously to achieve total flooding results. Configuring a total flooding system using Ceasefire M Series Extinguishers for any premises requires a design process to be followed as defined in the system's manual.



Available in Clean agent (Fluoroketone (FK-5-1-12), ABC Powder MAP90 and ABC Powder MAP50.

# TYPICAL SCHEMATIC DRAWING

## OF AN INTEGRATED TOTAL FLOODING SYSTEM CONFIGURED USING M-SERIES AUTOMATIC EXTINGUISHERS

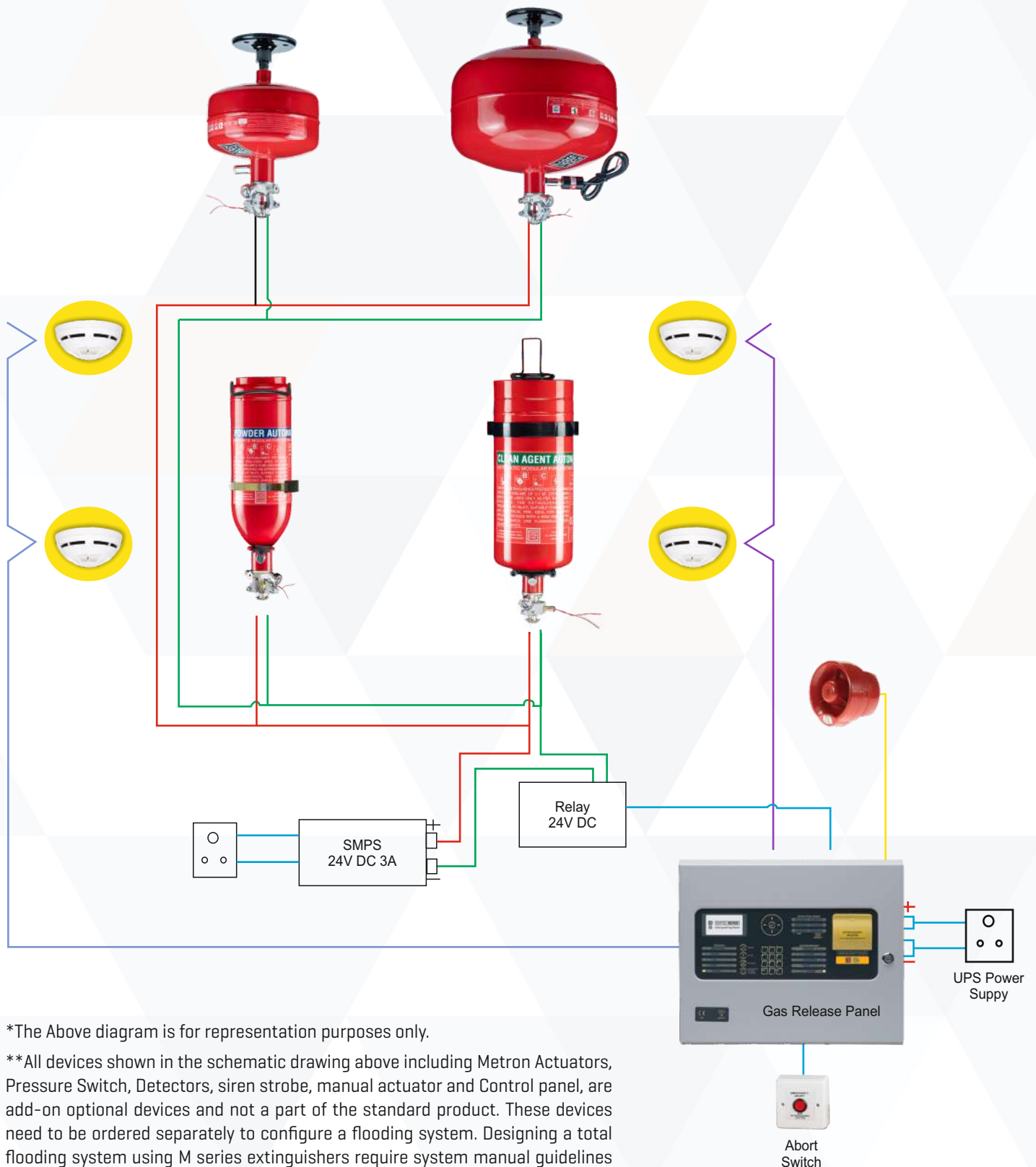

\*The Above diagram is for representation purposes only.

\*\*All devices shown in the schematic drawing above including Metron Actuators, Pressure Switch, Detectors, siren strobe, manual actuator and Control panel, are add-on optional devices and not a part of the standard product. These devices need to be ordered separately to configure a flooding system. Designing a total flooding system using M series extinguishers require system manual guidelines to be followed.

# FEATURES & BENEFITS OF

## OF AN INTEGRATED TOTAL FLOODING SYSTEM CONFIGURED USING M-SERIES AUTOMATIC EXTINGUISHERS



### Classification

Effective against all classes of fire.



### Certification

BSI tested, CE marked and UKCA approved.



### Agent Options

Available in Clean agent (Fluoroketone (FK-5-1-12), ABC Dry Powder MAP90 and ABC Dry Powder MAP50 .



### Monitorable System

Each of the extinguishing units (wall mounted or ceiling mounted) are monitorable in nature via the Control Panel with the presence of a pressure switch.



### Scalable Protection

The system is designed to be scalable in nature, where you can add wall mounted or ceiling mounted units to the existing network of extinguishing units to expand the protection area in order to meet your growing needs.



### Intelligent Detection

The detection module of the system can include devices that are most suitable to address the risks present at the premises.



### Cost Effective Solution

Since the system does not require so many fittings, fixtures and plumbing, it works out to be highly cost effective.



### Container Sizes

The system includes ceiling mounted extinguishing units in 2kg, 5kg, 10 kg and 15 kg and wall mounted extinguishing units in 1kg, 2kg, 4kg, 6kg and 9kg variants to suit diverse kinds of premises and applications.



### Easy To Install

The system is a retrofittable one and hence can be installed in a running and functional premises without hindering the daily business operations of the place. This is because minimal structural changes are required to be done in the premises to install the system.



### Consumes Minimal Productive Space

The system being ceiling / wall mounted consumes no floor space. Big boon for business premises where productive floor space is not consumed by the system's agent containers.

# SYSTEM COMPONENTS

## OF AN INTEGRATED TOTAL FLOODING SYSTEM CONFIGURED USING M-SERIES AUTOMATIC EXTINGUISHERS

### Ceiling Mounted Units

Ceiling mounted agent container units that saves productive floor space and activate together to create total flooding results.



### Wall Mounted Units

Wall mounted agent container units are included in the system where ceiling space is not available or accessible and targeted protection is required.

### Detection Sensors

The system has a wide-ranging line-up of detection devices such as smoke detectors, heat detectors, flame detectors, and beam detectors. A mix of these devices may be used in the system based on the fire hazard of the premises.



### Control Panel

The control panel receives signal from the detectors and actuates the system while also monitoring the system readiness via pressure switch. A control panel can actuate upto six automatic units simultaneously. This capacity can be increased further by adding additional relay.

## Metron Actuator (UL & CE Certified)

This is an essential device required to configure a total flooding system using M-Series Extinguishers. The metron actuator receives an electrical impulse from the panel and fires a metal pin inside the actuator that breaks the glass vial placed at the discharge point of M-Series extinguishers.



## Pressure Switch (UL & CE Certified)

The presence of pressure switch marks the extinguishing units monitorable in nature so the user can always check the system's readiness. This optional device's role is to convert a mechanical action into a switching effect that completes the circuit to send a signal to activate the third party devices such as fire alarm systems, sounder beacons or building management systems.



## Conventional Wall Sounder with Beacon

Ceasefire's Sounder with Beacon (optional) is a vital addition to our suite of fire safety solutions, engineered for effortless integration with all pressure switch-compatible solutions such as wall mounted and ceiling-mounted fire extinguishers. Built to respond instantly in emergencies, this high-performance device combines a brilliant strobe light with a powerful audible alarm to deliver clear, unmistakable alerts in the event of a fire, ensuring your premises stay protected at all times.



## Telescopic Arm

The optional telescopic arm ensures precise coverage of hard-to-reach fire risk zones, where protecting specific assets is the priority.



**UL & CE Certified**  
**PRESSURE SWITCH**



### TECHNICAL SPECIFICATIONS

Product Code	SM-RM4307
Description	Pressure Switch SPDT (Switch Point 5Bar / 72.5 PSIG decreasing) NC & NO -Imp
Increasing Activation	130 PSIG $\pm$ 9 PSIG [9 BAR]
Decreasing Activation	72.5 PSIG $\pm$ 7 PSIG [5 BAR]
Max Pressure	290 PSIG
Connector	NONE.
Fitting	M10 WITH DEFLATOR.
Fitting Material	BRASS.
Body Material	PLASTIC
Electrical Rating	3A 240 VAC/28 VDC.
Wire Jacket/insulator Material	PVC
O-ring Provided With Switch	NBR-70 SHORE (7.8X1.9 mm)
Certification	UL, RoHS, CE

UL & CE Certified

## METRON ACTUATOR WITH MOUNTING BRACKET



### TECHNICAL SPECIFICATIONS

TECHNICAL SPECIFICATIONS			
Nomenclature		UOM	Technical Detail
Description		-	Metron Actuator For Ceiling or Wall Mounted Atom X Pro
Product Code		-	SM-RM2431
Minimum Piston Stroke Length (mm)		(mm)	9.5
Body/Piston Material		-	Brass/Stainless Steel
Minimum Work Output (Joules)		Joules	4.9
Typical Peak Thrust (Newton's)		Newton's	1800
Service Life (Ambient) (Years)		-Years	10
Operating Temperature (OC)		OC)	-40 to +70
Electrical Resistance Range (Ohms)		Ohms	0.9 - 1.6
Maximum No Fire Current (Amps)	30 sec pulse	Amps	0.15
	0.05 sec pulse		0.3
Minimum Single Fire Current (Amps)	DC	Amps	0.6
	0.01 sec pulse		0.9
Recommended Series Firing Current (Amps)		Amps	3
Maximum distance of Metron head from the QBD		mm	7
Merton Threads on body		-	M 8 X 0.75

## CONTROL PANEL



### TECHNICAL SPECIFICATIONS

<b>Spare Part Code</b>	TI-002341
<b>Base technology</b>	Flash-based processor
<b>Display</b>	Backlit 128 x 64 LCD
<b>Remote status indicators</b>	Supported via RS485 (maximum of 7)
<b>Controls</b>	Alphanumeric keypad, navigation keys and system keys for Reset, Mute, Silence/Resound and Sound alarms
<b>Detection zones</b>	3 x conventional detection zones (inc. support for I.S. barrier)
<b>Extinguishing Zones</b>	1 x flooding/extinguishing zones. Support for solenoid and metron type actuators
<b>Onboard sounder circuits</b>	3 x 700mA, 21-28VDC
<b>Onboard relays</b>	4 x 1A, 30VDC relay outputs (Fire, Fault & 2 x programmable)
<b>Auxilliary supply</b>	2 x 400mA aux supply outputs 21-28VDC (1 switched)
<b>Programmable outputs</b>	Support for 8 additional programmable outputs via Exp-008
<b>Switch inputs</b>	4 x programmable, 1 x manual trigger, 6 x release related (Mode Select, Valve Monitor, Pressure Monitor, Hold, Abort, Flow)
<b>Countdown timer</b>	On board, large digit
<b>Mains supply</b>	3A universal switch mode PSU
<b>Battery capacity</b>	24V 7Ah
<b>Charger current</b>	1A
<b>USB ports</b>	1 x USB port for PC connection
<b>Event log</b>	1000 event time-stamped
<b>Enclosure, colour</b>	Steel IP30, grey RAL7035
<b>Cable entry</b>	17 knockouts in enclosure top, 13 in enclosure back
<b>Size (H x W x D)</b>	330mm x 400mm x 95mm
<b>Weight</b>	6Kg

## CONVENTIONAL WALL SOUNDER BEACON



### TECHNICAL SPECIFICATIONS

<b>Spare Part Code</b>	TI-002273
<b>Power supply voltage range</b>	15Vdc – 40Vdc
<b>Activated current load (High Vol.)</b>	11-25 mA at 24 Vdc
<b>Acoustic Frequency range</b>	400-2900 Hz
<b>Maximum acoustic Output</b>	100 dB(A) @ 1m
<b>Visual Alarm Device Frequency</b>	0.5 Hz or 1 Hz
<b>EN54-23 Classification</b>	W-2.5-7
<b>Temperature range (no icing)</b>	-25°C to +70°C
<b>Unit weight (inc Back box)</b>	290g
<b>Max humidity (non condensing)</b>	95% RH
<b>Ingress Protection</b>	IP 65

## CONVENTIONAL OPTICAL SMOKE & THERMAL DETECTOR



### TECHNICAL SPECIFICATIONS

	TI-002265	TI-002267 / TI-002268
Spare Product Code	TI-002265	TI-002267 / TI-002268
Alarm Temperature	—	78oC (Class BS)
Operating Voltage	10-30V DC	10-30V DC
Standby Current Consumption	90 $\mu$ A @ 24V DC	90 $\mu$ A @ 24V DC
Max. Alarm Current Consumption	40mA	40mA
Max. Remote Output Current	18mA	18mA
Ambient Temperature	-10°C to +55°C	-10°C to +55°C
Relative Humidity	95% (non condensing)	95% (non condensing)
Dimensions (Diameter x Height)	110mm (Ø) x 54mm (depth)	110mm (Ø) x 54mm (depth)
Standard	EN 54-7	EN 54-7
LED Indicator	Bi-coloured LED indicator with 3600 visibility.	—
Certification/Approval Authority	LPCB	LPCB
Protection Class	Ip40	Ip40

## DETECTOR BASE



### TECHNICAL SPECIFICATIONS

<b>Spare Part Code</b>	TI-002270
<b>Dimensions</b>	110mm x 16mm
<b>Weight</b>	50g
<b>Temperature Range (no icing)</b>	-10°C to +55°C
<b>Max humidity (non condensing)</b>	95% RH
<b>Cable size</b>	6mA @ 24Vdc

FEATURING

# CEASEFIRE LAUNCHER

## EXTINGUISHER + MODULAR SUPPRESSION SYSTEM

The Ceasefire Launcher is a futuristic product that takes firefighting to a level the world has yet to experience. The extinguisher, powered with MAP 90, is made for firefighting. Just aim it at the flames, and it's ready to go. No one around to detect the fire? This one-of-a-kind extinguisher launches into a standalone, modular suppression system when it senses a rise in temperature over 60°C. Ensuring that no fire ever goes undetected and unaddressed. The biggest pro of this revolutionary extinguisher is that it eliminates the need for the firefighter to go near the fire. This is a huge benefit, especially in the case of a large blaze. As for a con, we're still to find one.

Tested by **bsi.**



FIGHTS CLASS

**A B C ⚡**

CERTIFICATIONS

**CE 1128 UK CA**

In the event of a large fire, it allows the firefighter to launch the fire extinguisher in the direction of the flames and rush to safety, while the extinguisher automatically activates and extinguishes the flames.

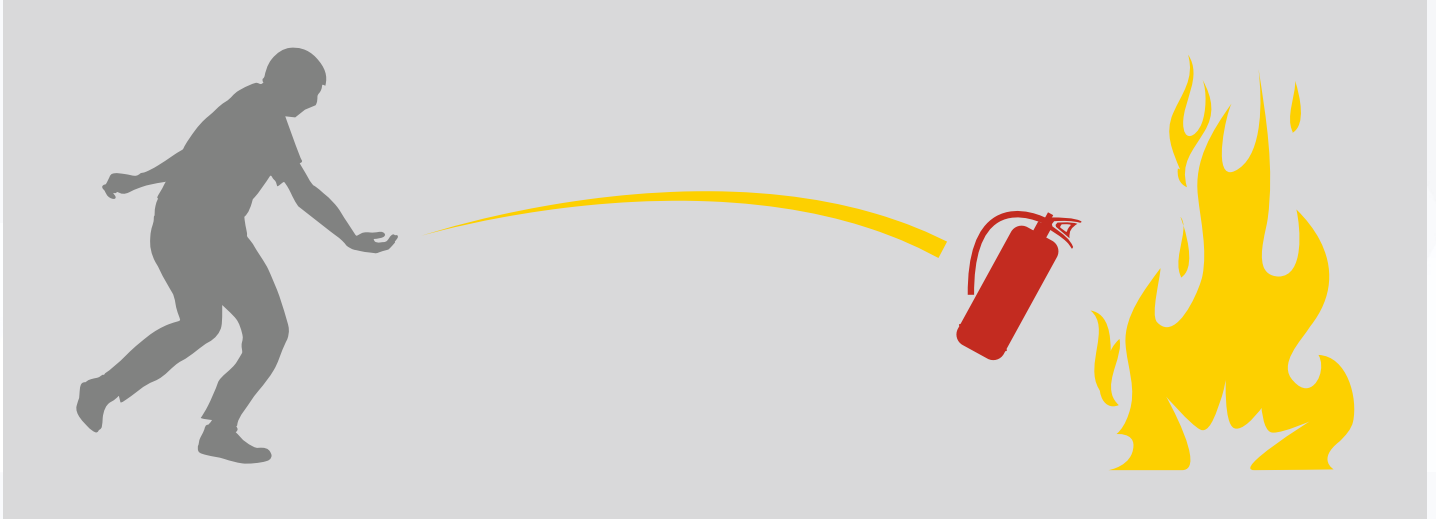

## HOW THE LAUNCHER WORKS

- 1 The Launcher as a Fire Extinguisher:** Powered by MAP 90, the highest form of ABC powder used for firefighting. Designed to engage in seconds to battle the flames. Easy to carry, it allows you to get to the scene of the fire quickly and use it effectively. In its simplest form, the Launcher is a thorough firefighter. All you need to do is aim the extinguisher at the fire, and the Launcher takes care of the rest. But to underestimate the Launcher as a simple fire extinguisher is a mistake. It's more. Much more.



## 2 The Launcher as an Auto-Pilot System:

The Launcher is the first of its kind extinguisher in the world, armed with two heat sensor and two unique discharge nozzles that face in opposite directions. When rolled or launched at the fire, the heat sensors automatically sense the rise in temperature and activate the extinguisher. Instantly, MAP 90 is released through the nozzles. Since the nozzles are placed opposite to one another, no matter which way the extinguisher is facing, the powder chemically interferes with the fire, blanketing and extinguish the flames.

### The Launcher in action



## 3 The Launcher as a Suppression System:

We understand that there may be times when no one is on the scene when a fire breaks out. Which means that there's no one there to launch the extinguisher in the direction of the flames. Pre-empting such situations, Ceasefire built the Launcher to be able to transform into a standalone, modular suppression system when no one is around. The heat sensors on the Launcher detect a rise in temperature in the room and activate the system. Flooding the room with MAP 90 that causes a chemical interference with the fire, and brings it under control.





## FEATURES & BENEFITS OF CEASEFIRE LAUNCHER



### Deep Drawn Body

The shell of the Launcher is made using deep drawn process. The decrease in welding seam makes it leakproof and allows it to attain a high burst capacity.



### Two Heat Sensors

Armed with two heat sensors, that pick up temperatures over 60°C, activating the system automatically as a suppression system.



### Convenient Handle

The handle allows the firefighter to use the extinguisher with ease. It also helps at the time of the extinguisher being launched at the fire.



### Self-actuation

Since the Launcher can be self-actuated, it enables safe evacuation eliminates the fire and stands guard at high fire risk areas.



### Unique Discharge Mechanism

Fitted with a thermal activation device, it ensures a 360-degree discharge for optimum suppression effect.



### State-of-the-art Pressure Gauge

If the pressure needle is in the green zone, it indicates that the extinguisher is in perfect working condition.



### Works On All Classes Of Fire

In a fire situation, there is no time to think about which extinguisher to use on which kind of fire. The Launcher can be used on any kind of fire, making it a truly versatile firefighter.



### Works Effectively On All Axis

Launcher is designed to function irrespective of the angle it is thrown in. The flexible dip tube enables the agent to discharge in a uniform fashion as intended to fight fires.



### Glow-in-the-Dark Label

For ease of visibility and quick access even in complete darkness

Scan the QR code to know more about the product



# TECHNICAL SPECIFICATIONS

Nomenclature	Launcher Automatic Fire Ext. 4 KG MS SP Red	Launcher Automatic Fire Ext. 6 KG MS SP Red	Launcher Automatic Fire Ext. 9 KG MS SP Red
Product Code	CF-000727	CF-000728	CF-000729
Agent	ABC Powder MAP 90	ABC Powder MAP 90	ABC Powder MAP 90
Certification Standards	PED	PED	PED
CE	Yes	Yes	Yes
UKCA	Yes	Yes	Yes
BSI Tested*	Yes	Yes	Yes
Gross Weight (approx.)	8.7 kg	11.5 kg	16.8 kg
Net Mass (approx.)	4 kg	6 kg	9 kg
Maximum Area Covered	3.30 m <sup>2</sup>	5.88 m <sup>2</sup>	9.29 m <sup>2</sup>
Discharge Mechanism	Squeeze Grip / Automatic QBD**	Squeeze Grip / Automatic QBD**	Squeeze Grip / Automatic QBD**
Fire Ratings	21A, 144B	27A, 183B	43A, 233B
Can Construction	Deep Drawn & MIG Welded	Deep Drawn & MIG Welded	Deep Drawn & MIG Welded
Valve/Cap Construction	Forging & Machining	Forging & Machining	Forging & Machining
External Coating	Epoxy Polyester Powder	Epoxy Polyester Powder	Epoxy Polyester Powder
Operating Temp.	-30°C to +60°C	-30°C to +60°C	-30°C to +60°C
Min. Discharge Time	13 sec	15 sec	23 sec
Warranty in Years	5	5	5
Working Pressure	15 Bar	15 Bar	15 Bar
Height of Fire Ext. (approx)	505 mm	545 mm	675 mm
Dia. of Shell (OD)	140 mm	160 mm	175 mm
Hydrostatic Test Pressure	35 Bar	35 Bar	35 Bar
Body Thickness	1.6 mm	1.6 mm	2 mm

\*Certificate awaited.

\*\*Quartzoid bulb in alternate temperature settings as mentioned below are available on request and would be dependent on MOQ for your region. Please check the availability and delivery time before ordering.

## QUARTZOID BULB KEY\*\*

● 57°C / 135°F

● 68°C / 155°F

● 79°C / 174°F

● 93°C / 200°F

● 141°C / 286°F

FEATURING

# CEASEFIRE MINI<sub>PRO</sub>

## MICRO-ENVIRONMENT FIRE SUPPRESSION

Introducing the Ceasefire Mini Pro, the biggest, smallest suppression system in town; and proof that some of the best things do come in small packages.

The Mini Pro is a state-of-the-art micro-environment suppression system that comes equipped with a provision to be made monitorable by pressure switch. The size of your palm, it sits snugly inside small enclosed spaces that are vulnerable to fire. When the temperature of the micro-environment exceeds a preset limit, the Mini Pro swings into action and automatically extinguishes the fire. Place it inside your server. Pop it in the fuse box. The Mini fits anywhere, and protects everywhere!

### EVOLVED TO PROTECT

Provision of a pressure port in the new improvised Mini Pro makes it monitorable in nature by using a pressure switch. With this unique upgrade the user can integrate Mini with any third-party device such as a Fire Alarm System or a Standalone Sounder Beacon.



### Monitoring Capability

Presence of a pressure port in Mini allows it to be connected to a pressure switch. This makes Mini monitorable in nature, so the user can always check the unit's readiness and can be alerted on its activation by integrating Mini with any third-party device such as a Fire Alarm System, a Standalone Sounder Beacon or a Building Management System.



## TYPES OF CEASEFIRE MINI PRO

Ceasefire has designed a Mini to protect practically every kind of micro-environment, including those that cannot be reached by humans.



### Mini Pro – Intuitive System

The Mini – Intuitive System is a direct suppression system which protects the micro-environment from inside. Place it inside or attach it to the inner wall of the micro-environment, and the Mini is ready to protect.



### Mini – Adaptive System

The Mini – Adaptive System is a direct suppression system designed for those micro-environments which are too small to even accommodate a Mini, let alone other firefighting systems. In this case, the Mini container is installed outside, with its heat-sensitive glass bulb inside the micro-environment.

## COMPONENTS OF THE MINI PRO



### Heat-sensitive Glass Bulb:

The Mini's heat-sensitive glass bulb acts as the heat detector. In case the temperature inside the micro-environment rises beyond a preset level, the glass bulb breaks to activate the system. In the Intuitive System, the glass bulb is attached to the main container. While in the Adaptive System, it is attached to a stainless steel barrel which extends from the container.

Ceasefire has specifically designed glass bulbs depending on the temperature conditions of the micro-environment to be protected.

■ In low-temperature settings, like air-conditioned offices, hospitals, server rooms, etc., 57°C is the ideal temperature for electrical cabinets.

### QUARTZOID BULB KEY\*

● 57°C / 135°F   ● 68°C / 155°F   ● 79°C / 174°F   ● 93°C / 200°F   ● 141°C / 286°F

\*Quartzoid bulb in alternate temperature settings as mentioned above are available on request and would be dependent on MOQ for your region. Please check the availability and delivery time before ordering.

\*\*The pressure switch shown in the picture of Mini above is for representation purposes only. It is an optional device and is not a part of the standard products.



## FEATURES & BENEFITS OF

### CEASEFIRE MINI<sup>PRO</sup>



#### Ease Of Use

Being automatic, the Mini requires no prompt to start firefighting.



#### Fits Anywhere

The Mini can easily fit into the spots that are most prone to fire.



#### Electronics-friendly

The Mini is filled with clean agent Fluoroketone (FK) that causes no damage to your electronics.



#### Works On All Classes Of Fire

The Mini can be used on any kind of fire, making it a truly versatile firefighter.



#### Heat-sensitive Glass Bulb

The Mini's glass bulb acts as a heat sensor that detects a rise in surrounding temperature.



#### Monitorable Option

These automatic extinguishers can be upgraded to become monitorable by opting for a pressure switch and integrating it with third-party devices.



#### Easy To Install With 2 Mounts

The Standard and Busbar mounts make installation a breeze.



#### Protects All Micro-Environments

Available as an Intuitive or Adaptive System, the Mini protects everywhere.



#### No Power Supply Required

The Mini uses a mechanical release mechanism to start firefighting.



#### Self-actuation

Since the Mini is self-actuated, it spots the fire and protects even when no one is around.



#### Maintenance-free

The Mini comes with a 5-year warranty and the assurance of no leakage.

Scan the QR code to know more about the product



# TECHNOLOGY MEETS DESIGN IN THE HANDY CEASEFIRE MINI<sup>PRO</sup>

Built to protect micro-environments, the Ceasefire Mini automatically kicks into action in a fire situation.

## a. ADAPTIVE SYSTEM

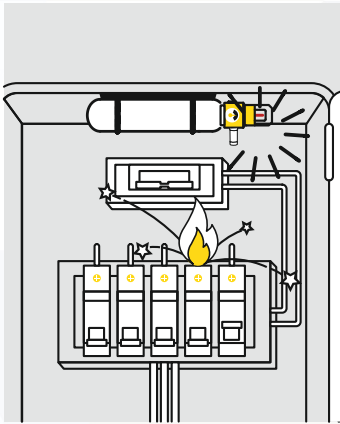

### Stage 1:

A fire sparked by a short circuit causes the pressure inside the Mini's glass bulb to increase.

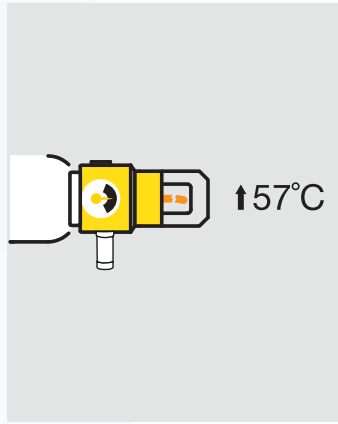

### Stage 2:

The very second the temperature rises beyond a point, the bulb breaks and activates the system.

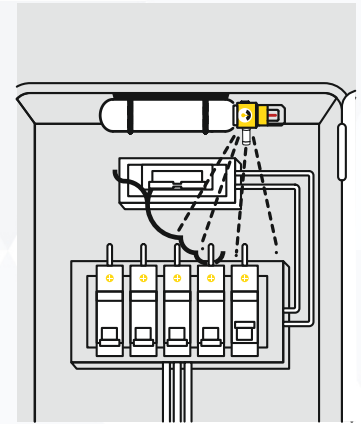

### Stage 3:

Instantly, the extinguishing agent is dispersed, killing the fire in its early stages.

## b. INTUITIVE SYSTEM

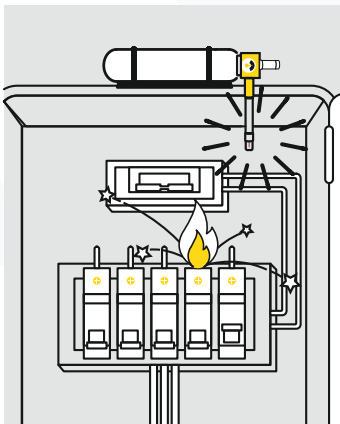

### Stage 1:

A fire sparked by a short circuit causes the pressure inside the Mini's glass bulb to increase.

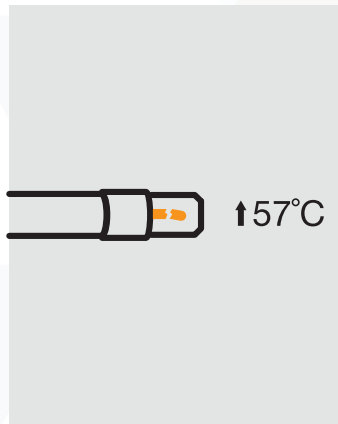

### Stage 2:

The very second the temperature rises beyond a point, the bulb breaks and activates the system.

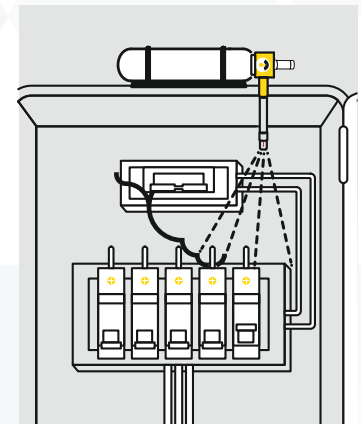

### Stage 3:

Instantly, the extinguishing agent is dispersed, killing the fire in its early stages.



The green Ceasefire Mini is available in Clean Agent Fluoroketone (FK).

Fluoroketone is a clean agent that causes no collateral damage to your electronics or the Earth, making the Mini absolutely safe.

# MINI SUPPRESSION SYSTEM. ZERO HASSLES.

Fitting the Mini is as easy as 1-2-3. It's the only suppression system in the market which can be installed without any help or technical support.

## INSTALLING THE MINI - ADAPTIVE SYSTEM

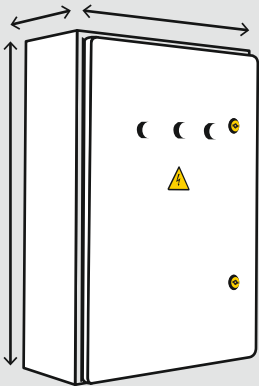

### Stage 1:

Measure the approximate volume of the enclosure you want to protect.

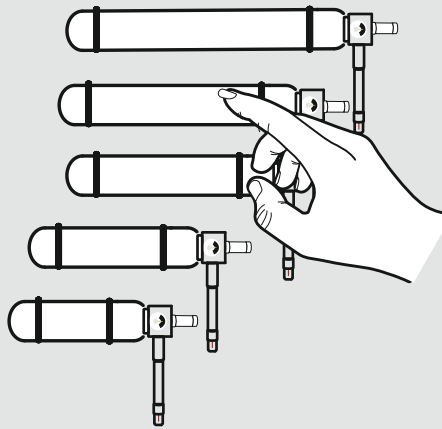

### Stage 2:

Choose the right variant of the Mini - Adaptive System.

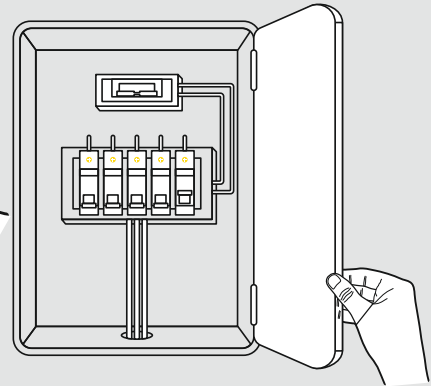

### Stage 3:

Drill a hole in the wall of your electrical cabinet.

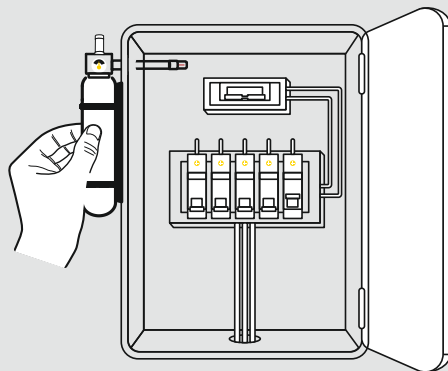

### Stage 4:

Place the Mini on the outside such that the barrel passes through the hole and the heat-sensing bulb is inside the cabinet.

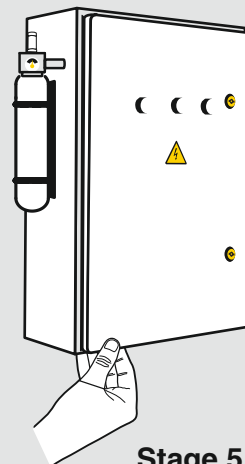

### Stage 5:

Close the enclosure.

# INSTALLING THE MINI - INTUITIVE SYSTEM

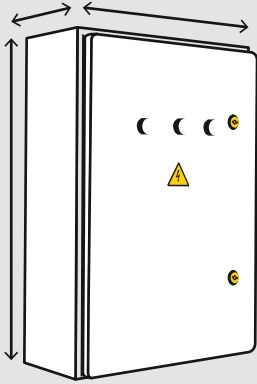

## Stage 1:

Measure the approximate volume of the enclosure you want to protect.

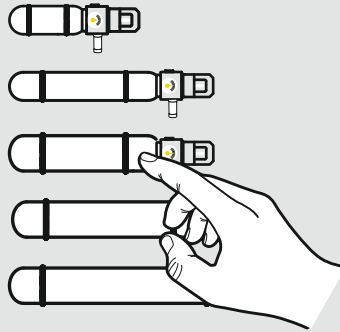

## Stage 2:

Choose the right variant of the Mini - Intuitive System.

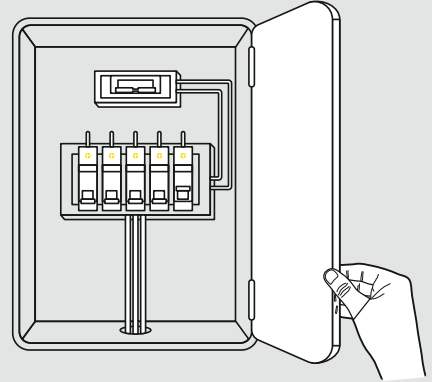

## Stage 3:

Open your electrical cabinet, AHU or machinery.

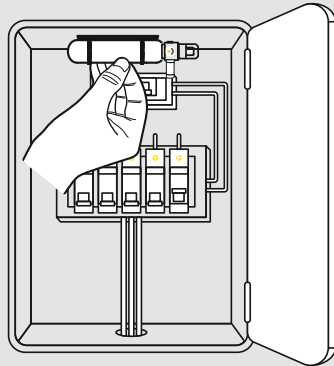

## Stage 4:

Place the Mini inside, vertically or horizontally. In case of large enclosures, you could screw its bracket to the wall inside and place the Mini on it.

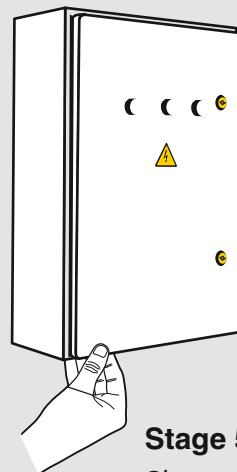

## Stage 5:

Close the enclosure.

# TECHNICAL SPECIFICATIONS

## INTUITIVE

Nomenclature	Mini Intuitive Automatic Fire Ext. 100gm SS SP Red	Mini Intuitive Automatic Fire Ext. 200gm SS SP Red	Mini Intuitive Automatic Fire Ext. 300gm SS SP Red	Mini Intuitive Automatic Fire Ext. 400gm SS SP Red	Mini Intuitive Automatic Fire Ext. 500gm SS SP Red
Product Code	CF-001339AP	CF-001341AP	CF-001343AP	CF-001345AP	CF-001347AP
Agent	Fluoroketone (FK-5-1-12)	Fluoroketone (FK-5-1-12)	Fluoroketone (FK-5-1-12)	Fluoroketone (FK-5-1-12)	Fluoroketone (FK-5-1-12)
Certification Standards	PED	PED	PED	PED	PED
CE	Yes	Yes	Yes	Yes	Yes
UKCA	Yes	Yes	Yes	Yes	Yes
BSI Tested*	Yes	Yes	Yes	Yes	Yes
Gross Weight (approx.)	0.665 kg	0.90 kg	1.10 kg	1.25 kg	1.45 kg
Net Mass (approx.)	100 gm	200 gm	300 gm	400 gm	500 gm
Maximum Volume Covered	0.130 m <sup>3</sup>	0.260 m <sup>3</sup>	0.390 m <sup>3</sup>	0.520 m <sup>3</sup>	0.650 m <sup>3</sup>
Discharge Mechanism	Automatic QBD**	Automatic QBD**	Automatic QBD**	Automatic QBD**	Automatic QBD**
Can Construction	Deep Drawn & MIG Welded		Deep Drawn & MIG Welded		
Valve/Cap Construction	Machining	Machining	Machining	Machining	Machining
External Coating	Epoxy Polyester Powder		Epoxy Polyester Powder		
Operating Temp.	-30°C to +60°C	-30°C to +60°C	-30°C to +60°C	-30°C to +60°C	-30°C to +60°C
Min. Discharge Time	1 to 3 sec	1 to 3 sec	1 to 3 sec	1 to 3 sec	1 to 3 sec
Warranty in Years	5	5	5	5	5
Working Pressure	10 Bar / 12 Bar	10 Bar / 12 Bar	10 Bar / 12 Bar	10 Bar / 12 Bar	10 Bar / 12 Bar
Height of Fire Ext. (approx)	184 mm	284 mm	276 mm	331 mm	386 mm
Dia. of Shell (OD)	40 mm	40 mm	50 mm	50 mm	50 mm
Hydrostatic Test Pressure	35 Bar	35 Bar	35 Bar	35 Bar	35 Bar
Body Thickness	1.2 mm	1.2 mm	1.2 mm	1.2 mm	1.2 mm

\*Certificate awaited.

\*\*Quartzoid bulb in alternate temperature settings as mentioned below are available on request and would be dependent on MOQ for your region. Please check the availability and delivery time before ordering.

### QUARTZOID BULB KEY\*\*

● 57°C / 135°F

● 68°C / 155°F

● 79°C / 174°F

● 93°C / 200°F

● 141°C / 286°F

## ADAPTIVE

Nomenclature	Mini Intuitive Automatic Fire Ext. 100 gm SS SP Red	Mini Intuitive Automatic Fire Ext. 200 gm SS SP Red	Mini Intuitive Automatic Fire Ext. 300 gm SS SP Red	Mini Intuitive Automatic Fire Ext. 400 gm SS SP Red	Mini Intuitive Automatic Fire Ext. 500 gm SS SP Red
Product Code (w/50 mm Barrel)	CF-001340AAP	CF-001342AAP	CF-001344AAP	CF-001346AAP	CF-001348AAP
Product Code (w/100 mm Barrel)	CF-001340ABP	CF-001342ABP	CF-001344ABP	CF-001346ABP	CF-001348ABP
Product Code (w/200 mm Barrel)	CF-001340ACP	CF-001342ACP	CF-001344ACP	CF-001346ACP	CF-001348ACP
Agent	Fluoroketone (FK-5-1-12)	Fluoroketone (FK-5-1-12)	Fluoroketone (FK-5-1-12)	Fluoroketone (FK-5-1-12)	Fluoroketone (FK-5-1-12)
Certification Standards	PED, BSI Tested*	PED, BSI Tested*	PED, BSI Tested*	PED, BSI Tested*	PED, BSI Tested*
CE	Yes	Yes	Yes	Yes	Yes
UKCA	Yes	Yes	Yes	Yes	Yes
Gross Weight (approx.)	0.665 kg	0.90 kg	1.10 kg	1.25 kg	1.45 kg
Net Mass (approx.)	100 gm	200 gm	300 gm	400 gm	500 gm
Maximum Volume Covered	0.130 m <sup>3</sup>	0.260 m <sup>3</sup>	0390 m <sup>3</sup>	0.520 m <sup>3</sup>	0.650 m <sup>3</sup>
Discharge Mechanism	Automatic QBD**	Automatic QBD**	Automatic QBD**	Automatic QBD**	Automatic QBD**
Can Construction	Deep Drawn & MIG Welded		Deep Drawn & MIG Welded		
Valve/Cap Construction	Machining	Machining	Machining	Machining	Machining
External Coating	Epoxy Polyester Powder		Epoxy Polyester Powder		
Operating Temp.	-30°C to +60°C	-30°C to +60°C	-30°C to +60°C	-30°C to +60°C	-30°C to +60°C
Min. Discharge Time	1 to 3 sec	1 to 3 sec	1 to 3 sec	1 to 3 sec	1 to 3 sec
Warranty in Years	5	5	5	5	5
Working Pressure	10 Bar / 12 Bar	10 Bar / 12 Bar	10 Bar / 12 Bar	10 Bar / 12 Bar	10 Bar / 12 Bar
Height of Fire Ext. (approx)	184 mm	284 mm	276 mm	331 mm	386 mm
Dia. of Shell (OD)	40 mm	40 mm	50 mm	50 mm	50 mm
Hydrostatic Test Pressure	35 Bar	35 Bar	35 Bar	35 Bar	35 Bar
Body Thickness	1.2 mm	1.2 mm	1.2 mm	1.2 mm	1.2 mm

\*Certificate awaited.

\*\*Quartzoid bulb in alternate temperature settings as mentioned below are available on request and would be dependent on MOQ for your region. Please check the availability and delivery time before ordering.

### QUARTZOID BULB KEY \*\*

● 57°C / 135°F

● 68°C / 155°F

● 79°C / 174°F

● 93°C / 200°F

● 141°C / 286°F



## **CEASEFIRE NEXT**

**NEW AGE FIRE SOLUTIONS FOR NEW  
AGE RISKS**

# MEET MULTIMAX L-ION

## FIREFIGHTING MADE SIMPLE.

One extinguisher. Every fire. Complete control.

Ceasefire MultiMax L-ion is a breakthrough, next-generation solution engineered to eliminate confusion and maximise action during fire emergencies. Unlike conventional extinguishers that work only on specific fire types, MultiMax is ahead of its time, an innovation in fire safety technology built to tackle the full spectrum of fire classes with a single universal agent.













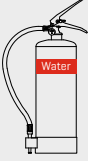

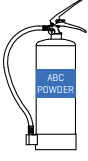

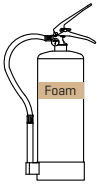

FIGHTS CLASS

A B C F ⚡ 🔥 Li

CERTIFICATIONS



# WHAT MAKES MULTIMAX OUTSHINE THE REST







Extinguisher Type	Where It's Typically Used	Consequence of Wrong Usage
Water  	Class A fires (wood, paper, textiles)	Causes electrocution on electrical fires; splashes and spreads flammable liquids; dangerous on oil fires 
Powder  	Class A, B, C fires (general purpose use).	Leaves corrosive residue; damages sensitive equipment; creates visibility & suffocation hazards in enclosed spaces. 
CO <sub>2</sub>  	Electrical fires, sensitive equipment.	Ineffective on flammable liquids, gases, or solids; oxygen depletion in enclosed spaces can cause suffocation. 
Foam  	Class A & B fires (flammable liquids like petrol, diesel, paints; paper & fabric fires).	Ineffective and causes electrocution on electrical fires; not suitable for oil/fat (Class F) fires; may leave slippery surfaces, creating additional hazards. 
Wet Chemical  	Class F fires (cooking oils, deep fat fryers, commercial kitchens).	Limited use beyond kitchen application. 
MultiMax  	All major fire classes [A, B, C, ESF, F, and Lithium Battery fires].	No confusion, no damage, no risks, one extinguisher for every fire. Clean sweep firefighting. 

Agent Type / Fire Class	A	B	C	E	F	Li
Dry Powder	✓	✓	✓	✓	✗	✗
CO <sub>2</sub>	✗	✓	✗	✓	✗	✗
Water	✓	✗	✗	✗	✗	✗
Foam	✓	✓	✗	✗	✗	✗
Wet Chemical	✓	✗	✗	✓	✓	✗
MultiMax	✓	✓	✓	✓	✓	✓

## FIRE SMART AND EARTH SAFE

Deadly to fires, gentle on the planet.

In today's world, safety must go hand-in-hand with sustainability. MultiMax doesn't compromise.

	Non-corrosive		100% biodegradable
	No PFAS/PFOA		Non-conductive
	Fluorine-free		Multi class fire fighting

## GLOBALLY CERTIFIED. RIGOROUSLY TESTED.

Certified trust for high-stakes environments.

**MultiMax carries the certifications that matter:**

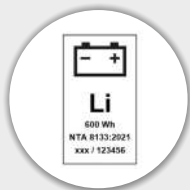

### NTA 8133 A1:2025 Certified

Certified to the latest amendment of the standard

### BSI Kitemark Certified

Approved by the British Standards Institution



### CE Marked & UKCA Approved

Compliant with stringent European safety benchmarks



# NTA 8133 A1:2025 CERTIFIED

## The Latest Standard in Lithium-ion Battery Fire Safety

The NTA 8133 A1:2025 is the very latest from Kiwa, a Dutch Technical Agreement specifically designed for testing portable fire extinguishers intended to combat lithium-ion battery fires (up to 600 Wh).

It fills a critical gap in existing fire safety standards that do not adequately address the unique challenges posed by lithium battery fires.



**NTA**  
8133 A1:2025



### NTA 8133 A1:2025- The Current Benchmark

The original reference for lithium-ion battery fire testing has been NTA 8133, which established a structured methodology for testing and evaluating fire extinguishers' performance against lithium battery fire conditions. This has evolved into its latest version, NTA 8133 A1:2025, incorporating refinements to testing procedures and evaluation criteria.



### BS EN 3-11- The Future Lithium Battery Fire Testing Standard

Ceasefire MultiMax being certified to NTA 8133 A1:2025, which is set to evolve into BS EN 3-11, is the highest and most renowned certification currently available worldwide. The BSI framework too has recognised NTA 8133 A1:2025 as the current reference standard, providing a credible and structured basis for testing extinguisher performance on Class L fires.

# Why is NTA 8133 A1:2025 Important?

## 1. Unique Fire Behavior

Lithium battery fires involve **thermal runaway**, resulting in intense and prolonged flames significantly different from conventional solid, liquid, or gas fires. The NTA 8133 Standard is specially designed to test fire extinguishers on such high intensity lithium battery fires.

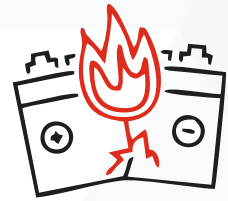

## 2. What does it mean?

As the NTA 8133 A1:2025 replaces the earlier NTA 8133:2021 version, it is now the current benchmark for lithium-ion fire extinguisher testing.

# NTA

8133 A1:2025



### This means:

- Any manufacturer still testing to the NTA 8133:2021 version may not be fully aligned with the new testing frameworks.
- Testing and certifications are aligned with the latest 2025 standard.
- Buyers and specifiers will expect compliance with the latest version.

## 3. Reliable Protection Where Risks Overlap

Testing of MultiMax to NTA 8133 A1:2025 makes it highly relevant for modern industrial and commercial environments where multiple fire risks exist. In situations where even a small delay in response can escalate damage, MultiMax provides a dependable, multi-risk solution, enabling faster first response, reducing fire severity, and helping protect people, property, and business continuity.

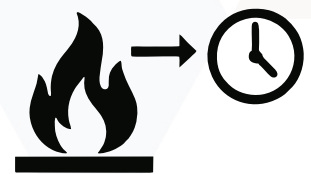

# CEASEFIRE MULTIMAX

## CERTIFIED TO THE LATEST NTA 8133 A1:2025 STANDARD

Ceasefire MultiMax fire extinguishers (the 6-litre and 9-litre variants) hold the distinction of being tested to the latest NTA 8133 A1:2025 standard. With BSI recognising NTA 8133 A1:2025 as the current reference test method for lithium battery fire extinguishers, and also being the closest precursor to the upcoming EN3-11 standard, MultiMax is validated against the most credible and widely accepted standard in use today.



### The Grim Reality

1. Many extinguishers in the market are still tested to the earlier 2021 version, which has now been withdrawn, making them less aligned with current lithium-ion fire risks and testing standards.
2. Moreover, many of these extinguishers are tested on Nickel Manganese Cobalt (NMC) cells, which exhibit higher stability during lithium-ion battery fire testing, instead of Lithium Cobalt Manganese (LCO) which exhibit higher thermal runaway, on which Ceasefire MultiMax extinguishers are tested.
3. Furthermore, many manufacturers rely on their internal testing methods, which may not fully reflect the severity and variability of real-world lithium-ion fire conditions.

## SECURE TRANSPORT BRACKET

When safety travels with you, it must stay secure. The specially engineered Transport Brackets for MultiMax extinguishers ensure your fire protection is as reliable on the move as it is on-site. Available for 500ml, 1 Litre and 2 Litre MultiMax extinguishers, these brackets are designed to keep your extinguishers secure in vehicular or other high vibration applications.



**Designed exclusively for transport applications, these brackets provide:**

- **Vibration-free installation** – Ensuring stability on uneven roads and rough terrains.
- **Heavy-duty grip** – Keeps the extinguisher firmly in place, preventing accidental dislodging.
- **Compact, space-optimised design** – Ideal for confined vehicle interiors.
- **Multi-environment adaptability** – Suited for vehicles, boats, and high vibration applications.

With MultiMax and its Transport Bracket system, fire safety extends seamlessly to your fleets, mobile setups, and transit applications.



## FEATURES & BENEFITS OF MULTIMAX L-ION EXTINGUISHERS



### Multi-Class Fire Protection

Fights Class A, B, C\*, ESF, F, and Lithium Battery fires



### Safe for Electronics & Equipment

Non-corrosive – Safe For Electronics and Critical Equipment



### Clean Discharge, Minimal Residue

Eco-safe discharge with minimal residue



### Quick & Easy to Use

Compact, easy to deploy in panic situations



### User-Friendly

Easy To Use Mechanism Usable by any Staff Member



### Warranty

These Ceasefire Extinguishers come with a 5-year warranty ensuring complete peace of mind.



### Non-conductive

Does not conduct electricity, ensuring safe application on live equipment



### Green & Safe Solution

100% Biodegradable & PFAS/PFOA-Free



### Globally Certified Protection

NTA 8133, BSI Certification and CE mark ensures reliable quality



### Glow-in-the-Dark Label

For ease of visibility and quick access even in complete darkness

Scan the QR code to know more about the product



# TECHNICAL SPECIFICATIONS (PORTABLE TYPE EXTINGUISHERS)

Nomenclature	MultiMax L-ion Ext. 500ml MS SP Red	MultiMax L-ion Ext. 1 Ltr MS SP Red	MultiMax L-ion Ext. 2 Ltr MS SP Red	MultiMax L-ion Ext. 3 Ltr MS SP Red	MultiMax L-ion Ext. 6 Ltr MS SP Red	MultiMax L-ion Ext. 9 Ltr MS SP Red
Stored Pressure / Cartridge	Stored Pressure	Stored Pressure	Stored Pressure	Stored Pressure	Stored Pressure	Stored Pressure
Agent	CF Green 100%	CF Green 100%	CF Green 100%	CF Green 100%	CF Green 100%	CF Green 100%
Product Code	CF-001551	CF-001552	CF-001535	CF- 001536	CF-001537	CF-001538
Certification	PED (CE Marked)		PED (CE MARKED), KITEMARKED		PED (CE MARKED), KITEMARKED, Tested To NTA 8133 Standard	
CE	Yes	Yes	Yes	Yes	Yes	Yes
UKCA	Yes	Yes	Yes	Yes	Yes	Yes
Gross Weight (approx.)	1.50 Kg	1.98 Kg	3.65 Kg	5.00 Kg	9.40 Kg	13.40 Kg
Net Contents (approx.)	500 ml	1 Ltr	2 Ltr	3 Ltr	6 Ltr	9 Ltr
Approx. Height Of Fire Ext.	300 mm	350 mm	390 mm	380 mm	520 mm	610 mm
Discharge Mechanism	Squeeze Grip	Squeeze Grip	Squeeze Grip	Squeeze Grip	Squeeze Grip	Squeeze Grip
Applicable On Fires	Class A, B, C*, ESF, F, and Li-Battery		Class A, B, C*, ESF, F, and Li-Battery		Class A, B, C*, ESF, F, and Li-Battery	
Fire Rating to EN 3-7	1A**, 8B, F**	2A**, 13B, 5F	8A, 34B, 5F	8A, 55B, 25F	21A, 144B, 40F	27A, 183B, 40F
Battery Rating to NTA 8133	—	—	—	—	600 W/h	600 W/h
Can Construction	Deep Drawn & MIG Welded		Deep Drawn & MIG Welded		Deep Drawn & MIG Welded	
Valve / Cap Construction	Forging And Machining		Forging And Machining		Forging And Machining	
Internal Coating	Plastic Lining	Plastic Lining	Plastic Lining	Plastic Lining	Plastic Lining	Plastic Lining
External Coating	Epoxy Polyester Powder		Epoxy Polyester Powder		Epoxy Polyester Powder	
Warranty In Years	5	5	5	5	5	5
Average Discharge Duration as per BS EN 3-7:2004+A1:2007, clause 7.1.2	10.5 sec***	11.5 sec***	12.5 sec	13.5 sec	28 sec	40 sec
Throw up to (approx.)***	2 meter	2 meter	5 meter	5 meter	6 meter	6 meter
Working Pressure	15 Bar	15 Bar	15 Bar	15 Bar	15 Bar	15 Bar
Dia. Of Shell (OD)	77.5 mm	92 mm	112 mm	145 mm	217 mm	236 mm
Operating Temperature	5°C to 60°C	5°C to 60°C	5°C to 60°C	5°C to 60°C	5°C to 60°C	5°C to 60°C
Hydrostatic Test Pressure	30 Bar	30 Bar	30 Bar	30 Bar	30 Bar	30 Bar
Cylinder Material Spec.	Steel CR2(DC01)	Steel CR2(DC01)	Steel CR2(DC01)	Steel CR2(DC01)	Steel CR2(DC01)	Steel CR2(DC01)
Body Thickness	1.2 mm	1.0 mm	1.4 mm	1.2 mm	1.4 mm	1.4 mm

\*Tested for Class C Fire as per Australian Standard [AS/NZS 1850:2009].

\*\*Derated.

\*\*\*As per in-house testing.

For detailed information, please refer to the product datasheets.

INTRODUCING

# CEASEFIRE FLUORINE FREE FOAM PORTABLE FIRE EXTINGUISHERS

Recognizing the dynamic shifts in industry requirements and the urgent call for environmentally conscious solutions, Ceasefire presents Fluorine-Free Foam Extinguishers. As the world navigates towards a future that places a premium on environmental responsibility, our Fluorine-Free Foam Extinguishers take centre stage as the pioneering solution.

Positioned at the forefront of innovation, Ceasefire's Fluorine-Free Foam Extinguishers are the first of its kind that are poised to redefine the standards of fire safety, offering not just a product but a game-changing approach towards safeguarding lives and the environment.



FIGHTS CLASS

A B

CERTIFICATIONS



## CHEMICAL FOAM: A DATED DILEMMA

The traditional foam fire extinguishers contain or may contain Perfluorooctanesulfonic acid (PFOS) or Perfluorooctanoic acid (PFOA). These fluorine chemicals are associated with C8 chemistry, are extremely stable and remain mobile in the environment for many decades.

These chemicals are a risk to the environment and human health, being a persistent organic pollutant (also termed as forever chemicals) found to accumulate in the general environment and human tissues with deleterious effects to both.



Understanding this serious environmental concern, governments across the globe are recognizing the need for a balance between effective firefighting and ecological responsibility, and have begun to shape the discourse around the usage of foam-based extinguishing agents.

**“The UK Environment Agency is expected to prohibit the manufacture and sale of Aqueous Film-Forming Foam (AFFF), the most common type of foam extinguisher containing PFAS, by 2024.**

## PAVING THE WAY TO A GREEN FUTURE

Traditionally, fire extinguishers have utilised foam formulations containing fluorine-based compounds, which, while effective in suppressing fires, raise concerns about environmental impact and safety.



In response to these challenges, Ceasefire has pioneered an innovative range of extinguishers that completely eliminate the use of fluorine. This Fluorine-Free technology not only ensures uncompromised fire extinguishing capability but also aligns with global environmental sustainability goals. Engineered to provide a safer and eco-friendly alternative, Ceasefire's Fluorine-Free Foam Fire Extinguishers mark a significant leap towards a greener and more responsible future in fire safety. As the industry shifts towards more environmentally conscious solutions, our Fluorine-Free Foam Extinguishers stand as a testament to Ceasefire's commitment to both effective firefighting and ecological responsibility.

# FEATURES & BENEFITS OF FLUORINE FREE FOAM EXTINGUISHERS



## Fluorine-free Formulation

Eliminates the use of fluorine-based compounds for an eco-friendly and sustainable fire extinguishing solution.



## Green Screen Silver Certified Agent

This agent is totally free of fluorinated derivatives (PFAS including PFOS, PFOA) and is 100% biodegradable.



## EN 1568-1/2/3/4 Compliant Agent

The standard critically tests foam for both extinguishment and burnback in sea and potable (fresh) water.



## Innovation In Action

A paradigm shift in fire safety technology, providing a safer and more sustainable choice for safeguarding lives and the environment.



## Aspirating Nozzles

Unique aspirating nozzle design ensures high ratings and effectiveness on Class B fires.



## Inner Plastic Coating

The inner plastic coating ensures the containers stay rust-free in the long run.



## World-class Quality

Comprehensive Helium Tests and Leak Tests also guarantee that the products you buy are manufactured according to the world's most stringent quality standards.



## Glow-in-the-Dark Label

For ease of visibility and quick access even in complete darkness



## Cutting-edge Technology

Advanced Ceasefire technology ensures optimal firefighting power per unit of the agent.



## Versatility

Works on Class A and B fires providing a comprehensive solution.



## Deep Drawn Container

Manufactured using a state-of-the-art deep draw process ensuring minimal seams and sturdy container body.



## User-friendly Design

Engineered for ease of handling, ensuring effective deployment during emergencies by individuals of varying experience levels.



## Warranty

The Ceasefire Fluorine-Free Foam Extinguisher comes with a 5-year warranty ensuring complete peace of mind.



## Global Compliance

Meets and exceeds international safety standards, offering a globally compliant solution for enhanced fire safety.



## Certifications

Ceasefire Fluorine Free Foam Fire Extinguishers are LPCB, Kitemark, EU-MED, UKCA-MER, CE and UKCA Certified.

Scan the QR code to  
know more about  
the product



# TECHNICAL SPECIFICATIONS

Nomenclature	Fire Ext FFF 3L MS SP Red	Fire Ext FFF 6L MS SP Red	Fire Ext FFF 9L MS SP Red
Stored Pressure / Cartridge	Stored Pressure	Stored Pressure	Stored Pressure
Agent	Water + Fluorine Free Foam 6%	Water + Fluorine Free Foam 6%	Water + Fluorine Free Foam 6%
Product Code	CF-001479*	CF-001480*	CF-001481*
Certification Standards	BS EN3, PED, EU-MED, UKCA-MER	BS EN3, PED, EU-MED, UKCA-MER	BS EN3, PED, EU-MED, UKCA-MER
LPCB	Yes	Yes	Yes
Kitemark	Yes	Yes	Yes
EU-MED	Yes	Yes	Yes
UKCA-MER	Yes	Yes	Yes
CE	Yes	Yes	Yes
UKCA	Yes	Yes	Yes
Gross Weight (approx.)	5.50 Kg	9.60 Kg	13.65 Kg
Net Contents (approx.)	3 Ltr	6 Ltr	9 Ltr
Approx. Height Of Fire Ext.	445 mm	520 mm	615 mm
Discharge Mechanism	Squeeze Grip	Squeeze Grip	Squeeze Grip
Applicable On Fires	A & B	A & B	A & B
Fire Ratings	8A, 55B	13A, 113B	21A, 183B
Average Discharge Duration as per BS EN 3-7:2004+A1:2007, clause 7.1.2	9 sec	12 sec	12 sec
Throw up to (approx.)	5 meter	5 meter	6 meter
Can Construction	Deep Drawn & MIG Welded	Deep Drawn & MIG Welded	Deep Drawn & MIG Welded
Valve / Cap Construction	Forging And Machining	Forging And Machining	Forging And Machining
Internal Coating	Plastic Lining	Plastic Lining	Plastic Lining
External Coating	Epoxy Polyester Powder	Epoxy Polyester Powder	Epoxy Polyester Powder
Warranty In Years	5	5	5
Working Pressure	15 Bar	15 Bar	15 Bar
Dia. Of Shell (OD)	140 mm	160 mm	175 mm
Operating Temperature	5°C to 60°C	5°C to 60°C	5°C to 60°C
Hydrostatic Test Pressure	30 Bar	30 Bar	30 Bar
Cylinder Material Spec.	Steel CR2(DC01)	Steel CR2(DC01)	Steel CR2(DC01)
Body Thickness	1.2 mm	1.4 mm	1.4 mm

\*Available with additional hanging bracket.

INTRODUCING

# CEASEFIRE GREEN MAX

## FLUORINE FREE FOAM PORTABLE FIRE EXTINGUISHERS

Ceasefire Green Max range of extinguishers deliver high-performance firefighting using advanced fluorine-free foam technology, combining effective fire suppression with a strong commitment to environmental responsibility.

Green Max extinguishers are developed without fluorinated chemicals such as PFOA and PFAS, making them a safer and more sustainable alternative to conventional foam extinguishers. The advanced formulation ensures rapid flame knockdown, effective surface cooling, and prevention of re-ignition, while maintaining clean operation with minimal residue.

Designed for modern environments, Green Max is suitable for Class A, Class B, electrically started fires, and Class F cooking oil fires. Its spray-based discharge enables controlled application, ensuring safe use even in occupied and enclosed spaces without excessive disruption or visibility impairment.



FIGHTS CLASS

A B F ⚡

CERTIFICATIONS





## FEATURES & BENEFITS OF GREEN MAX EXTINGUISHERS



### Effective Multi-Class Protection

Suitable for Class A, Class B, electrically started fires, and Class F fires, making it ideal for diverse fire risks.



### Environmentally Responsible

Developed with fluorine-free foam technology, completely free from PFOA and PFAS, ensuring no long-term environmental impact.



### Clean Performance

Leaves minimal residue, reducing post-fire damage and enabling faster recovery of operations.



### World-Class Quality

BSI Kitemark certified, CE marked, and UKCA compliant, conforming to stringent BS EN3 standards.



### 5-Year Warranty

Backed by a reliable 5-year warranty for long-term assurance and peace of mind.



### Controlled Spray Discharge

Enables uniform application of agent, better fire control, and safe usage in occupied and enclosed environments.



### Safe for Modern Spaces

Designed for use in areas with people, sensitive equipment, and confined environments without excessive disruption.



### Glow-in-the-Dark Label

For ease of visibility and quick access even in complete darkness

Scan the QR code to know more about the product



# TECHNICAL SPECIFICATIONS (PORTABLE TYPE EXTINGUISHERS)

Nomenclature	Green Max Ext. 2 Ltr MS SP Red	MultiMax L-ion Ext. 3 Ltr MS SP Red	MultiMax L-ion Ext. 6 Ltr MS SP Red	MultiMax L-ion Ext. 9 Ltr MS SP Red
Stored Pressure / Cartridge	Stored Pressure	Stored Pressure	Stored Pressure	Stored Pressure
Agent	Flourine Free Foam (Premix 100%)	Flourine Free Foam (Premix 100%)	Flourine Free Foam (Premix 100%)	Flourine Free Foam (Premix 100%)
Product Code	CF-001478S	CF-001479S	CF-001480S	CF-001481S
Certification	PED (CE MARKED), KITEMARKED		PED (CE MARKED), KITEMARKED	
CE	Yes	Yes	Yes	Yes
UKCA	Yes	Yes	Yes	Yes
Gross Weight (approx.)	3.65 Kg	5.00 Kg	9.40 Kg	13.40 Kg
Net Contents (approx.)	2 Ltr	3 Ltr	6 Ltr	9 Ltr
Approx. Height Of Fire Ext.	390 mm	380 mm	520 mm	610 mm
Discharge Mechanism	Squeeze Grip	Squeeze Grip	Squeeze Grip	Squeeze Grip
Applicable On Fires	Class A, B, F, and ESF	Class A, B, F, and ESF	Class A, B, F, and ESF	Class A, B, F, and ESF
Fire Rating to EN 3-7	8A, 34B, 5F	8A, 55B, 25F	21A, 144B, 40F	27A, 183B, 40F
Can Construction	Deep Drawn & MIG Welded	Deep Drawn & MIG Welded	Deep Drawn & MIG Welded	Deep Drawn & MIG Welded
Valve / Cap Construction	Forging And Machining	Forging And Machining	Forging And Machining	Forging And Machining
Internal Coating	Plastic Lining	Plastic Lining	Plastic Lining	Plastic Lining
External Coating	Epoxy Polyester Powder	Epoxy Polyester Powder	Epoxy Polyester Powder	Epoxy Polyester Powder
Warranty In Years	5	5	5	5
Average Discharge Duration as per BS EN 3-7:2004+A1:2007, clause 7.1.2	9 sec	9 sec	15 sec	15 sec
Throw up to (approx.)***	2 meter	4 meter	5 meter	5 meter
Working Pressure	15 Bar	15 Bar	15 Bar	15 Bar
Dia. Of Shell (OD)	112 mm	145 mm	217 mm	236 mm
Operating Temperature	5°C to 60°C	5°C to 60°C	5°C to 60°C	5°C to 60°C
Hydrostatic Test Pressure	30 Bar	30 Bar	30 Bar	30 Bar
Cylinder Material Spec.	Steel CR2(DC01)	Steel CR2(DC01)	Steel CR2(DC01)	Steel CR2(DC01)
Body Thickness	1.4 mm	1.2 mm	1.4 mm	1.4 mm

FEATURING

# CEASEFIRE CLEAN AGENT (FK-5-1-12) BASED PORTABLE FIRE EXTINGUISHERS

Research shows that short circuits in the electrical mains or in sensitive electronic equipment such as computers, server racks, CNC machines, etc., are the most common cause of fire in workspaces. While powder-based extinguishers can certainly defeat these fires, they cause serious collateral damage.

That's where Ceasefire's Clean Agent Fluoroketone (FK) based Extinguishers come in. These extinguishers are built to not only put out fires, but save sensitive electronic equipment too. Powered by one of the cleanest, most powerful extinguishing agents on the planet, these extinguishers are extremely lightweight, yet are power-packed with an immense throw that penetrates even the finest mesh and spaces.



FIGHTS CLASS

**B** ⚡

CERTIFICATIONS



# FEATURES & BENEFITS OF CLEAN AGENT FK BASED EXTINGUISHERS



## Safe On Electronic Equipment

Clean gas FK-based extinguishers leave no residue and can be used on electronic equipment.



## Lightweight

Extremely lightweight, yet packed with tremendous power and throw, to penetrate past even the finest grills and meshes.



## Simplicity In Handling

The easy-grip handle aids simplicity in handling.



## Pressure Gauge

The state-of-the-art pressure gauge can be tested onsite, using a special magnet to ensure that it is working perfectly and is 100% accurate.



## World-class Quality

Comes with LPCB, Kitemark, EU-MED, UKCA-MER, CE, and UKCA certification, and conforms to BSEN standards. Comprehensive Helium Tests and Leak Tests also guarantee that the products you buy are manufactured according to the world's most stringent quality standards.



## Warranty

These Ceasefire Extinguishers come with a 5-year warranty ensuring complete peace of mind.



## Free From F-gas Regulations

FK being outside the purview of F-gas regulation gives freedom of operation to businesses and offers a long term trade solution.



## Types Of Fire

Fights Class B & Electrically Started Fires.



## EPDM Rubber Hosepipe

This durable, long-lasting pipe doesn't develop any cracks under normal wear and tear conditions.



## Safe On Environment

Fluoroketone (FK) gas is amongst the most potent yet environment-friendly solutions with a Global Warming Potential (GWP) of less than 1 and a Ozone Depletion Potential (ODP) of 0.



## Glow-in-the-Dark Label

For ease of visibility and quick access even in complete darkness

Scan the QR code to know more about the product











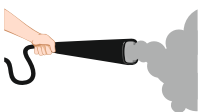

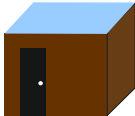

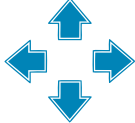
# WHY CHOOSE FLUOROKETONE ?

The need of the hour is to have extinguishing technologies that are potent on fire as well as safe to use in the presence of people.

Fluoroketone (FK) as an agent, does not reduce the oxygen level, it extinguishes by chemical reaction and is safe to use in confined areas as per the NFPA guidelines. In addition to this, the BS5306 does not recommend CO to be used in confined areas.

**Here is a quick comparison of FK agent for those wanting to make a purchase decision between FK and CO<sub>2</sub> extinguishers:**

Aspect	Fluoroketone Extinguishers	CO <sub>2</sub> Extinguishers
Safety For Occupants 	Absolutely safe for use in populated areas as it does not displace oxygen.	If used in an enclosed or poorly ventilated area, there is a serious risk of choking/asphyxiation.
Risk of Freeze Burns 	No freeze-burn risk at the time of use does not cause any hindrance during firefighting.	Freeze burns caused at the time of use hampers in firefighting.
Safe on Sensitive Equipment* 	Absolutely safe for use on sensitive equipment.	Has the potential to damage sensitive equipment due to static/thermal shock.
Safe In Enclosed Areas 	Safe for use in enclosed spaces with human presence as it does not displace oxygen. Recommended as per the NFPA guidelines.	Displaces oxygen, posing suffocation. Not recommended for enclosed, confined, and unventilated areas as per BS5306-8-2012.
Safe for Environment 	With less than 1 Global Warming Potential (GWP), makes it earth-friendly.	GWP of 1 causes higher environmental impact.
Stress Factor 	Low 10 bar pressure for safety of occupants.	High 70 bar pressure potentially dangerous for occupants.
Weight 	Light mild steel container body making it easy to lift and move.	Heavy steel container making it heavy to lift and move.

Aspect	Fluoroketone Extinguishers	CO <sub>2</sub> Extinguishers
Maneuverability 	Lightweight and easy to move around to reach the emergency spot on time.	Heavy weight of extinguishers make maneuverability difficult during a fire emergency.
Ease of Maintenance 	Light in weight aids in ease of maintenance.	Heavy, hence difficult to maintain.
Visual Monitoring 	Pressure gauge allows checking the health and readiness of the extinguisher.	No pressure gauge, manual weighing is the method for checking the readiness of the extinguisher.
Electrostatic Charge 	No static charge risk hence making it safe for the firefighter.	The risk of electrostatic charge makes using CO <sub>2</sub> extinguishers a challenge.
Agent Efficiency 	Approximately half the quantity of (FK) agent can create the same suppression effect as CO <sub>2</sub> .	Consumes larger quantities of agent compared to FK to create a similar suppression effect.
Classes of Fire* 	Effective on Electrically Started Fires as well as Class B.	Not recommended to be used on Electrically Started Fires in the presence of other classes of fire in the same environment.

\*As per BS5306 Part 8 - "It is unlikely that the electrical equipment itself will provide the major fuel source. The provision of extinguishers should therefore be decided on the basis of the other fire hazards in the area."



# TECHNICAL SPECIFICATIONS

Nomenclature	Fire Ext. 2 Kg MS SP Red	Fire Ext. 4 Kg MS SP Red	Fire Ext. 6 Kg MS SP Red	Fire Ext. 9 Kg MS SP Red
Stored Pressure/Cartridge	Stored Pressure	Stored Pressure	Stored Pressure	Stored Pressure
Product Code	CF-001333*	CF-001334*	CF-001335*	CF-001336*
Agent	Fluoroketone (FK-5-1-12)	Fluoroketone (FK-5-1-12)	Fluoroketone (FK-5-1-12)	Fluoroketone (FK-5-1-12)
Certification Standards	BS EN3, PED, EU-MED, UKCA-MER	BS EN3, PED, EU-MED, UKCA-MER	BS EN3, PED, EU-MED, UKCA-MER	BS EN3, PED, EU-MED, UKCA-MER
LPCB	Yes	Yes	Yes	Yes
Kitemark	Yes	Yes	Yes	Yes
EU-MED	Yes	Yes	Yes	Yes
UKCA-MER	Yes	Yes	Yes	Yes
CE	Yes	Yes	Yes	Yes
UKCA	Yes	Yes	Yes	Yes
Gross Weight (approx.)	3.75 kg	6.90 kg	9.50 kg	14.70 kg
Net Mass (approx.)	2 kg	4 kg	6 kg	9 kg
Discharge Mechanism	Thumb Triggered	Squeeze Grip	Squeeze Grip	Squeeze Grip
Fire Ratings	21B	34B	34B	55B
Can Construction	Deep Drawn & MIG Welded	Deep Drawn & MIG Welded	Deep Drawn & MIG Welded	Deep Drawn & MIG Welded
Valve/Cap Construction	Forging & Machining	Forging & Machining	Forging & Machining	Forging & Machining
External Coating	Epoxy Polyester Powder Coating	Epoxy Polyester Powder Coating	Epoxy Polyester Powder Coating	Epoxy Polyester Powder Coating
Operating Temp.	-30°C to +60°C	-30°C to +60°C	-30°C to +60°C	-30°C to +60°C
Average Discharge Duration as per BS EN 3-7:2004+A1:2007, clause 7.1.2	6 sec	6 sec	6 sec	9 sec
Throw up to (approx.)	3 meters	4 meters	4 meters	4 meters
Warranty in Years	5	5	5	5
Working Pressure	10 Bar	10 Bar	10 Bar	10 Bar
Height of Fire Ext. (approx)	370 mm	440 mm	485 mm	615 mm
Dia. of Shell (OD)	175 mm	240 mm	300 mm	300 mm
Hydrostatic Test Pressure	35 Bar	35 Bar	35 Bar	35 Bar
Body Thickness	1.6 mm	1.6 mm	1.6 mm	2 mm

\*Available with additional hanging bracket.

FEATURING

# CEASEFIRE WATER SPRAY

## PORTABLE FIRE EXTINGUISHERS

Water is a natural firefighting agent that helps bring down the temperature of the fire and the area around it. Ceasefire's Water Spray model extinguishers use specialised nozzels to create a fine spray of the extinguishant that makes it effective on Class A, F, and Electrically started fires.

The Ceasefire Water Spray model extinguishers are available in 6 Ltr. and 9 Ltr. capacities in both Stainless Steel and Mild Steel containers.



FIGHTS CLASS

A F ⚡

CERTIFICATIONS





## FEATURES & BENEFITS OF WATER SPRAY EXTINGUISHERS



### EPDM Rubber Hosepipe

This durable, long-lasting pipe doesn't develop any cracks under normal wear and tear conditions.



### Pressure Gauge

The state-of-the-art pressure gauge can be tested onsite, using a special magnet to ensure that it is working perfectly and is 100% accurate.



### World-class Quality

Comes with LPCB, Kitemark, EU-MED, UKCA-MER, CE, and UKCA certification, and conforms to BSEN standards. Comprehensive Helium Tests and Leak Tests also guarantee that the products you buy are manufactured according to the world's most stringent quality standards.



### Glow-in-the-Dark Label

For ease of visibility and quick access even in complete darkness



### Warranty

These Ceasefire Extinguishers come with a 5-year warranty ensuring complete peace of mind.



### Safe To Use On Electrical Fires

Suitable for use on live electrical equipment up to 1000 V from a distance of 1 meter.



### Types of Fire

Fights Class A, F & Electrically Started Fires.



### Special Nozzle

Extinguishant dispersed via a specially designed Spray Nozzle.

Scan the QR code to  
know more about  
the product



# TECHNICAL SPECIFICATIONS

Nomenclature	Fire Ext. 6 Ltr MS SP Red	Fire Ext. 6 Ltr SS SP Red	Fire Ext. 9 Ltr MS SP Red	Fire Ext. 9 Ltr SS SP Red
Stored Pressure/Cartridge	Stored Pressure	Stored Pressure	Stored Pressure	Stored Pressure
Product Code	CF-000798S*	CF-000717S*	CF-000799S*	CF-000718S*
Agent	Water	Water	Water	Water
Certification Standards	BS EN3, PED, EU-MED, UKCA-MER	BS EN3, PED, EU-MED, UKCA-MER	BS EN3, PED, EU-MED, UKCA-MER	BS EN3, PED, EU-MED, UKCA-MER
LPCB	Yes	Yes	Yes	Yes
Kitemark	Yes	Yes	Yes	Yes
EU-MED	Yes	Yes	Yes	Yes
UKCA-MER	Yes	Yes	Yes	Yes
CE	Yes	Yes	Yes	Yes
UKCA	Yes	Yes	Yes	Yes
Gross Weight (approx.)	9.80 kg	9.80 kg	14.50 kg	14.50 kg
Net Mass (approx.)	6 Ltr	6 Ltr	9 Ltr	9 Ltr
Discharge Mechanism	Squeeze Grip	Squeeze Grip	Squeeze Grip	Squeeze Grip
Fire Ratings	13A, 25F	13A, 25F	21A, 40F	21A, 40F
Can Construction	Deep Drawn & MIG Welded	Drawn Rolled & MIG Welded	Deep Drawn & MIG Welded	Drawn Rolled & MIG Welded
Valve/Cap Construction	Forging & Machining	Forging & Machining	Forging & Machining	Forging & Machining
External Coating	Epoxy Polyester Powder	Epoxy Polyester Powder	Epoxy Polyester Powder	Epoxy Polyester Powder
Operating Temp.	+5°C to +60°C	+5°C to +60°C	+5°C to +60°C	+5°C to +60°C
Average Discharge Duration as per BS EN 3-7:2004+A1:2007, clause 7.1.2	9 sec	9 sec	9 sec	9 sec
Throw up to (approx.)	7 meters	7 meters	7 meters	7 meters
Warranty in Years	5	5	5	5
Working Pressure	10 Bar	10 Bar	10 Bar	10 Bar
Height of Fire Ext. (approx)	520 mm	520 mm	615 mm	610 mm
Dia. of Shell (OD)	160 mm	260 mm	175 mm	175 mm
Hydrostatic Test Pressure	35 Bar	35 Bar	35 Bar	35 Bar
Body Thickness	1.6 mm	1.5 mm	2 mm	1.5 mm

\*Available with additional hanging bracket.

FEATURING

# CEASEFIRE FOAM SPRAY

## PORTABLE FIRE EXTINGUISHERS

The quickest way to kill a fire is by limiting the oxygen supply in the vicinity. Ceasefire's Foam Spray model extinguishers form a foam blanket, cutting down on the oxygen supply.

Ceasefire's Foam Spray model extinguishers use specialised nozzles to create a fine spray of the extinguishant that makes it effective on Class A, B, F, and Electrically started fires.



FIGHTS CLASS

A B F ⚡

CERTIFICATIONS





## FEATURES & BENEFITS OF FOAM SPRAY EXTINGUISHERS



### EPDM Rubber Hosepipe

This durable, long-lasting pipe doesn't develop any cracks under normal wear and tear conditions.



### Pressure Gauge

The state-of-the-art pressure gauge can be tested onsite, using a special magnet to ensure that it is working perfectly and is 100% accurate.



### World-class Quality

Comes with LPCB, Kitemark, EU-MED, UKCA-MER, CE, and UKCA certification, and conforms to BSEN standards. Comprehensive Helium Tests and Leak Tests also guarantee that the products you buy are manufactured according to the world's most stringent quality standards.



### Glow-in-the-Dark Label

For ease of visibility and quick access even in complete darkness



### Warranty

These Ceasefire Extinguishers come with a 5-year warranty ensuring complete peace of mind.



### Safe To Use On Electrical Fires

Suitable for use on live electrical equipment up to 1000 V from a distance of 1 meter.



### Types Of Fire

Fights Class A, B, F & Electrically Started Fires.



### Special Nozzle

Extinguishant dispersed via a specially designed Spray Nozzle.

Scan the QR code to  
know more about  
the product



# TECHNICAL SPECIFICATIONS

Nomenclature	Fire Ext. 3 Ltr MS SP Red	Fire Ext. 3 Ltr SS SP Red	Fire Ext. 6 Ltr MS SP Red	Fire Ext. 6 Ltr SS SP Red	Fire Ext. 9 Ltr MS SP Red	Fire Ext. 9 Ltr SS SP Red
Stored Pressure/Cartridge	Stored Pressure	Stored Pressure	Stored Pressure	Stored Pressure	Stored Pressure	Stored Pressure
Product Code	CF-000805S*	CF-000779S*	CF-000806S*	CF-000715S*	CF-000807S*	CF-000716S*
Agent	Water + 6% of KV Foam 3% C-6		Water + 6% of KV Foam 3% C-6		Water + 6% of KV Foam 3% C-6	
Certification Standards	BS EN3, PED, EU-MED, UKCA-MER		BS EN3, PED, EU-MED, UKCA-MER		BS EN3, PED, EU-MED, UKCA-MER	
LPCB	Yes	Yes	Yes	Yes	Yes	Yes
Kitemark	Yes	Yes	Yes	Yes	Yes	Yes
EU-MED	Yes	Yes	Yes	Yes	Yes	Yes
UKCA-MER	Yes	Yes	Yes	Yes	Yes	Yes
CE	Yes	Yes	Yes	Yes	Yes	Yes
UKCA	Yes	Yes	Yes	Yes	Yes	Yes
Gross Weight (approx.)	5.70 kg	5.75 kg	9.51 kg	9.51 kg	13.50 kg	14.92 kg
Net Mass (approx.)	3 Ltr	3 Ltr	6 Ltr	6 Ltr	9 Ltr	9 Ltr
Discharge Mechanism	Squeeze Grip	Squeeze Grip	Squeeze Grip	Squeeze Grip	Squeeze Grip	Squeeze Grip
Fire Ratings	8A, 89B, 25F	8A, 89B, 25F	13A, 144B, 40F	13A, 144B, 40F	21A, 233B, 75F	21A, 233B, 75F
Can Construction	Deep Drawn & MIG Welded		Deep Drawn & MIG Welded		Deep Drawn & MIG Welded	
Valve/Cap Construction	Forging & Machining		Forging & Machining		Forging & Machining	
External Coating	Epoxy Polyester Powder		Epoxy Polyester Powder		Epoxy Polyester Powder	
Operating Temp.	+5°C to +60°C	+5°C to +60°C	+5°C to +60°C	+5°C to +60°C	+5°C to +60°C	+5°C to +60°C
Average Discharge Duration as per BS EN 3-7:2004+A1:2007, clause 7.1.2	9 sec	9 sec	15 sec	15 sec	15 sec	15 sec
Throw up to (approx.)	7 meters	7 meters	7 meters	7 meters	7 meters	7 meters
Warranty in Years	5	5	5	5	5	5
Working Pressure	15 Bar	15 Bar	15 Bar	15 Bar	15 Bar	15 Bar
Height of Fire Ext. (approx)	440 mm	435 mm	520 mm	520 mm	615 mm	610 mm
Dia. of Shell (OD)	140 mm	140 mm	160 mm	160 mm	175 mm	175 mm
Hydrostatic Test Pressure	35 Bar	35 Bar	35 Bar	35 Bar	35 Bar	35 Bar
Body Thickness	1.6 mm	1.5 mm	1.6 mm	1.5 mm	2 mm	1.5 mm

\*Available with additional hanging bracket.

INTRODUCING

# CEASEFIRE WET CHEMICAL SPRAY

## PORTABLE FIRE EXTINGUISHERS

Ceasefire's Wet Chemical Spray Extinguishers are a versatile and eco-friendly fire safety solution ideal for high-risk environments like commercial kitchens. Featuring a biodegradable foaming agent, these extinguishers blanket flames, cut off oxygen, cool oil below its self-ignition point, and reduce re-ignition risks. They are effective on Class A, F, and Electrically started fires, and are also suitable for use on live electrical equipment up to 1000 V from a distance of 1 meter. Easy to use and reliable, Ceasefire's extinguishers offer rapid suppression across diverse fire scenarios, making them a crucial addition to any fire safety strategy.



FIGHTS CLASS

A F ⚡

CERTIFICATIONS





## FEATURES & BENEFITS OF WET CHEMICAL SPRAY EXTINGUISHERS



### EPDM Rubber Hosepipe

This durable, long-lasting pipe doesn't develop any cracks under normal wear and tear conditions.



### Warranty

These Ceasefire Extinguishers come with a 5-year warranty ensuring complete peace of mind.



### Pressure Gauge

The state-of-the-art pressure gauge can be tested onsite, using a special magnet to ensure that it is working perfectly and is 100% accurate.



### Safe To Use On Electrical Fires

Suitable for use on live electrical equipment up to 1000 V from a distance of 1 meter.



### World-class Quality

Comes with LPCB, Kitemark, EU-MED, UKCA-MER, CE, and UKCA certification, and conforms to BSEN standards. Comprehensive Helium Tests and Leak Tests also guarantee that the products you buy are manufactured according to the world's most stringent quality standards.



### Types of Fire

Fights Class A, F & Electrically Started Fires.



### Special Nozzle

Extinguishant dispersed via a specially designed Spray Nozzle.



### Glow-in-the-Dark Label

For ease of visibility and quick access even in complete darkness

Scan the QR code to  
know more about  
the product



# TECHNICAL SPECIFICATIONS

Nomenclature	Fire Ext. 3 Ltr MS SP Red	Fire Ext. 6 Ltr MS SP Red	Fire Ext. 9 Ltr MS SP Red
Stored Pressure/Cartridge	Stored Pressure	Stored Pressure	Stored Pressure
Product Code	CF-001482*	CF-001483*	CF-001484*
Agent	100% KV-LITE CLASS K FOAM	100% KV-LITE CLASS K FOAM	100% KV-LITE CLASS K FOAM
Certification Standards	BS EN3, PED, EU-MED, UKCA-MER	BS EN3, PED, EU-MED, UKCA-MER	BS EN3, PED, EU-MED, UKCA-MER
LPCB	Yes	Yes	Yes
EU-MED	Yes	Yes	Yes
UKCA-MER	Yes	Yes	Yes
CE	Yes	Yes	Yes
UKCA	Yes	Yes	Yes
Gross Weight (approx.)	7.40 kg	12.60 kg	17.85 kg
Net Mass (approx.)	3 Ltr	6 Ltr	9 Ltr
Discharge Mechanism	Squeeze Grip	Squeeze Grip	Squeeze Grip
Fire Ratings	8A, 89B, 25F	13A, 144B, 40F	21A, 233B, 75F
Can Construction	Deep Drawn & MIG Welded	Deep Drawn & MIG Welded	Deep Drawn & MIG Welded
Valve/Cap Construction	Forging & Machining	Forging & Machining	Forging & Machining
External Coating	Epoxy Polyester Powder	Epoxy Polyester Powder	Epoxy Polyester Powder
Operating Temp.	+5°C to +60°C	+5°C to +60°C	+5°C to +60°C
Average Discharge Duration as per BS EN 3-7:2004+A1:2007, clause 7.1.2	9 sec	15 sec	15 sec
Throw up to (approx.)	7 meters	7 meters	7 meters
Warranty in Years	5	5	5
Working Pressure	15 Bar	15 Bar	15 Bar
Height of Fire Ext. (approx)	440 mm	520 mm	615 mm
Dia. of Shell (OD)	140 mm	160 mm	175 mm
Hydrostatic Test Pressure	35 Bar	35 Bar	35 Bar
Body Thickness	1.6 mm	1.6 mm	2 mm

\*Available with additional hanging bracket.



# WATERMIST EXTINGUISHERS

THE GREENEST, CLEANEST MOST  
VERSATILE FIREFIGHTERS

# REVOLUTIONARY TECHNOLOGY: WATERMIST

It's common knowledge that there is no extinguishing agent more potent than water. With its massive cooling power of 2.6 MW per litre per second, water kills even the largest of fires in minutes. But even fire's worst adversary has its shortcomings. Using water on an electrically started blaze can be a fatal mistake. What you need is cutting-edge technology that changes water's natural form, so that it can fight fires without causing any collateral damage.

Water has the cooling power of  
2.6 MW per litre per second

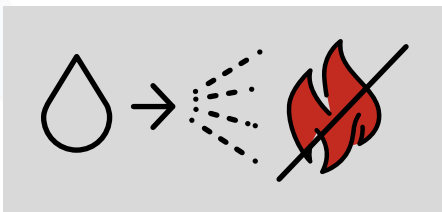
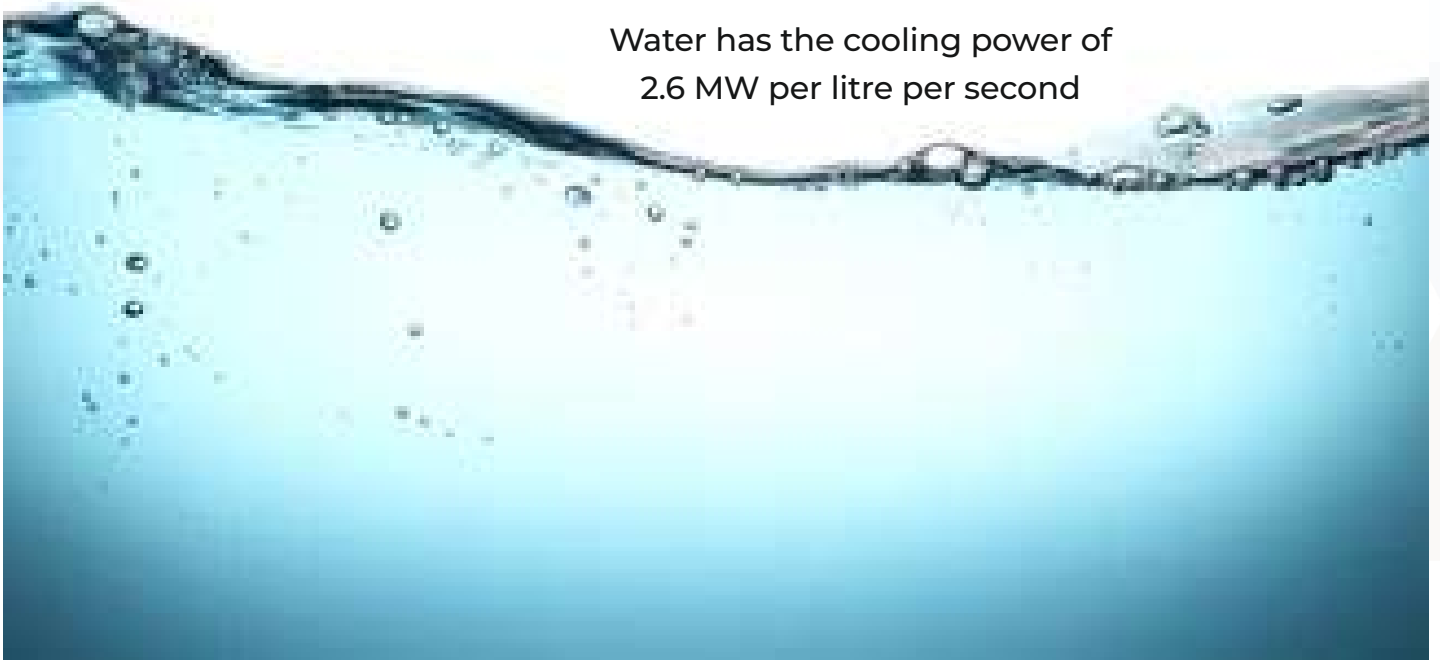

Not only does this firefighting system break water down into the exact micron size required to fight the flames, it gives Watermist the immense energy it needs to reach the fire at a force.

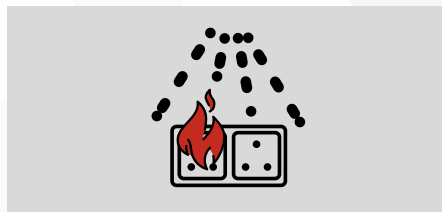

This makes it the only portable system of its kind that combines two revolutionary technologies – Watermist and stored pressure – into a portable extinguisher that can take down even the largest of fires, including electrically started fires.

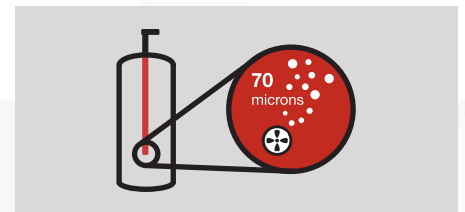

First, the Multi-Rotors located within the portable extinguisher turns water into droplets of 70 micron size by mixing it with air in a pre-set proportion.



This produces Watermist, which increases the coverage area of water to fight fires many times over. The TetraQuad then uses stored pressure technology to deliver Watermist with a kinetic force strong enough to overcome the fire's own convection currents.

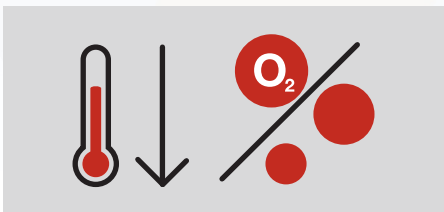

When Watermist falls on the fire, it rapidly brings down the temperature to below combustible levels, cuts off the oxygen supply and kills the flames.

Besides, being 100% green, Watermist causes no damage to equipment or the Earth. Making it absolutely safe to use on electronics, sensitive equipment and, above all else, human lives.



FEATURING

# CEASEFIRE WATERMIST PORTABLE FIRE EXTINGUISHERS

For centuries, man has done everything in his power to defeat fire. From bucketfuls of sand to advanced chemical powders and additives, from woollen blankets to sophisticated fire engines, all have been pitted against it.

Now, fire meets its fiercest opponent - the cleanest extinguishing agent known to man, Water. These extinguishers use stored pressure technology, advanced rotors and specially designed nozzles to generate an ultra-fine spray of water called Watermist. Watermist, when it comes in contact with fire evaporates rapidly, blocking the entry of oxygen in the fire zone and bringing down the temperature to below combustion levels. This green, all-natural extinguishing agent causes no collateral damage at all – not to your premises nor the ozone. It is tough on fire, yet gentle on the environment.



FIGHTS CLASS

A F ⚡

CERTIFICATIONS





## FEATURES & BENEFITS OF WATERMIST EXTINGUISHERS



### Water Efficient

Specially designed nozzles that convert water into a fine mist with minuscule droplets that increase the coverage of water in the fire zone.



### Solid Stainless Steel Body

Its solid stainless steel body can withstand high temperatures.



### Reduces damage

Uses filtered water, eliminating collateral damage.



### World-class Quality

Comes with LPCB, Kitemark, EU-MED, UKCA-MER, CE, and UKCA certification, and conforms to BSEN standards. Comprehensive Helium Tests and Leak Tests also guarantee that the products you buy are manufactured according to the world's most stringent quality standards.



### Safe To Use On Electrical Fires

Suitable for use on live electrical equipment up to 1000 V from a distance of 1 meter.



### Types Of Fire

Fights Class A, F & Electrically Started Fires.



### Warranty

These Ceasefire Extinguishers come with a 5-year warranty ensuring complete peace of mind.



### Environment Friendly

The use of distilled water in combination with cutting-edge technology ensures these extinguisher have no negative impact on the environment.



### Glow-in-the-Dark Label

For ease of visibility and quick access even in complete darkness

Scan the QR code to know more about the product



# TECHNICAL SPECIFICATIONS

Nomenclature	Fire Ext. Watermist 2 Ltr SS SP Red	Fire Ext. Watermist 3 Ltr SS SP Red	Fire Ext. Watermist 6 Ltr SS SP Red	Fire Ext. Watermist 9 Ltr SS SP Red
Stored Pressure/Cartridge	Stored Pressure	Stored Pressure	Stored Pressure	Stored Pressure
Product Code	CF-000709*	CF-000710*	CF-000711*	CF-000712*
Agent	Water	Water	Water	Water
Certification Standards	BS EN3, PED	BS EN3, PED, EU-MED, UKCA-MER	BS EN3, PED, EU-MED, UKCA-MER	BS EN3, PED, EU-MED, UKCA-MER
LPCB	Yes	Yes	Yes	Yes
Kitemark	Yes	Yes	Yes	Yes
EU-MED	No	Yes	Yes	Yes
UKCA-MER	No	Yes	Yes	Yes
CE	Yes	Yes	Yes	Yes
UKCA	Yes	Yes	Yes	Yes
Gross Weight (approx.)	4.50 kg	5.90 kg	10.60 kg	14.60 kg
Net Mass (approx.)	2 Ltr	3 Ltr	6 Ltr	9 Ltr
Discharge Mechanism	Thumb Triggered	Squeeze Grip	Squeeze Grip	Squeeze Grip
Fire Ratings	5A, 25F	8A, 25F	13A, 75F	21A, 75F
Can Construction	Drawn Rolled & MIG Welded	Drawn Rolled & MIG Welded	Drawn Rolled & MIG Welded	Drawn Rolled & MIG Welded
Valve/Cap Construction	Forging & Machining	Forging & Machining	Forging & Machining	Forging & Machining
External Coating	Epoxy Polyester Powder	Epoxy Polyester Powder	Epoxy Polyester Powder	Epoxy Polyester Powder
Operating Temp.	+5°C to +60°C	+5°C to +60°C	+5°C to +60°C	+5°C to +60°C
Average Discharge Duration as per BS EN 3-7:2004+A1:2007, clause 7.1.2	6 sec	9 sec	9 sec	9 sec
Throw up to (approx.)	3 meters	3 meters	3 meters	3 meters
Warranty in Years	5	5	5	5
Working Pressure	15 Bar	15 Bar	15 Bar	15 Bar
Height of Fire Ext. (approx)	485 mm	445 mm	575 mm	690 mm
Dia. of Shell (OD)	108 mm	140 mm	175 mm	175 mm
Hydrostatic Test Pressure	35 Bar	35 Bar	35 Bar	35 Bar
Body Thickness	1.5 mm	1.5 mm	1.5 mm	1.5 mm

\* Available with additional hanging bracket.

FEATURING

# CEASEFIRE FOAM MIST PORTABLE FIRE EXTINGUISHERS

Ceasefire Foam Mist extinguisher range harnesses the combined power of revolutionary watermist technology and foam in portable extinguishers.

The extinguishing agent is 99% water and 1% foam-based chemical agent (as compared to 3–6% foaming agent used by industry players), making the agent significantly greener within the foam segment. The foam-mist-based firefighting system forms a foam blanket over the fire, eliminating the entry of oxygen and suppressing the fire instantly. Simultaneously, the watermist component delivers a powerful cooling effect, preventing any chances of re-ignition.

It is effective against Class A, Class B, electrically started fires, and kitchen fires. With no flooding-related collateral damage and safe usage in human presence, it offers a reliable and efficient fire protection solution.



FIGHTS CLASS

A B F ⚡

CERTIFICATIONS





## FEATURES & BENEFITS OF FOAM MIST & GREEN-FOAM MIST EXTINGUISHERS



### EPDM Rubber Hosepipe

This durable, long-lasting pipe doesn't develop any cracks under normal wear and tear conditions.



### World-class Quality

Comes with LPCB, Kitemark, EU-MED, UKCA-MER, CE, and UKCA certification, and conforms to BSEN standards. Comprehensive Helium Tests and Leak Tests also guarantee that the products you buy are manufactured according to the world's most stringent quality standards.



### Pressure Gauge

The state-of-the-art pressure gauge can be tested onsite, using a special magnet to ensure that it is working perfectly and is 100% accurate.



### Warranty

These Extinguishers come with a 5-year warranty ensuring complete peace of mind.



### Discharge Mechanism

A simple discharge mechanism allows you to control the discharge and optimize the use of the extinguishing agent.



### Low Water Usage

Ceasefire's Foam mist & Green-Foam mist Extinguishers generate mist with 40-60 micron droplets, thus using many times less water than conventional water jets.



### High Firefighting Effectiveness

Thanks to a vast evaporation surface, nearly 100% of the mist delivered through Ceasefire Foam Mist Extinguishers evaporates and engulfs the fire, making for a more powerful and efficient extinguisher.



### Types Of Fire

Fights class A, B, F & Electrically Started Fires.



### Glow-in-the-Dark Label

For ease of visibility and quick access even in complete darkness

Scan the QR code to know more about the product



# TECHNICAL SPECIFICATIONS

Nomenclature	Fire Ext. Foammist 2 Ltr SS SP Red	Fire Ext. Foammist 6 Ltr SS SP Red
Stored Pressure/Cartridge	Stored Pressure	Stored Pressure
Product Code	CF-000696*	CF-000698*
Foaming Agent	1%	1%
Certification Standards	BS EN3, PED, EU-MED, UKCA-MER	BS EN3, PED, EU-MED, UKCA-MER
LPCB	Yes	Yes
Kitemark	Yes	Yes
EU-MED	Yes	Yes
UKCA-MER	Yes	Yes
CE	Yes	Yes
UKCA	Yes	Yes
Gross Weight (approx.)	4.50 kg	10.60 kg
Net Mass (approx.)	2 Ltr	6 Ltr
Discharge Mechanism	Squeeze Grip	Squeeze Grip
Fire Ratings	5A, 55B, 25F	13A, 144B, 40F
Can Construction	Drawn Rolled & MIG Welded	Drawn Rolled & MIG Welded
Valve/Cap Construction	Forging & Machining	Forging & Machining
External Coating	Epoxy Polyester Powder	Epoxy Polyester Powder
Operating Temp.	+5°C to +60°C	+5°C to +60°C
Average Discharge Duration as per BS EN 3-7:2004+A1:2007, clause 7.1.2	9 sec	15 sec
Throw up to (approx.)	3 meters	3 meters
Warranty in Years	5	5
Working Pressure	15 Bar	15 Bar
Height of Fire Ext. (approx)	485 mm	575 mm
Dia. of Shell (OD)	108 mm	175 mm
Hydrostatic Test Pressure	35 Bar	35 Bar
Body Thickness	1.5 mm	1.5 mm

\* Available with additional hanging bracket.

FEATURING

# CEASEFIRE ACTION-PAC

## PORTABLE WATERMIST AND FOAM MIST EXTINGUISHERS

Presenting the Ceasefire Action-Pac extinguisher, the first of its kind in the world. Powered by 100% Watermist, this backpack & trolley-mounted fire extinguisher is packed with immense fire fighting power and can easily be carried to the scene of the fire to battle the flames.



FIGHTS CLASS

A B ⚡

CERTIFICATIONS

CE UK  
1128 CA

# FEATURES & BENEFITS OF ACTION-PAC EXTINGUISHERS



## Easy To Use With Quick Activation

Being a stored pressure extinguisher, the Action-Pac requires no cartridge system (internal or external) activation. It's always ready. Simply press the trigger to activate.



## Available In Pure Watermist Or In Watermist + Foam

The Action-Pac is available in two variants, as per your needs.



## Does Not Require Any Electricity

The Action-Pac doesn't require any electricity to function. It's always ready to fight the flames.



## 1 Minute Of Continuous Discharge

Packed with 60 seconds of extinguishing power.



## Watermist Ensures No Flooding

Since the mist evaporates quickly, there is no chance of flooding and collateral damage.



## EPDM Rubber Hosepipe

This durable, long-lasting pipe doesn't develop any cracks under normal wear and tear conditions.



## Environment Friendly

The Action-Pac uses bio-degradable foam and water to fight fires. Making it an extinguisher that also protects the Earth.



## Safe On Humans

Since the Action-Pac uses Watermist to suppress fires, it can safely be used around people. It's ideal for places where there is high human traffic, like cinemas and auditoriums.



## Low Pressure, Safe Technology

Being a low pressure extinguisher, there are no risks involved in case the extinguisher is used by mistake, even if people are around.



## Safe To Use On Electrical Fires

Suitable for use on live electrical equipment up to 1000 V from a distance of 1 meter.



## Types Of Fire

Fights class A, B, & Electrically Started Fires.



## Anti-bacterial Additive

This additive prevents any kind of bacterial growth in the water, keeping the water clean and fresh.



## Ideal For Rapid Reaction

Activated in seconds and lightweight, the Action-Pac is ideal for single person response fire situations.



## Spray And Jet Modes

The Jet Mode delivers a large amount of the extinguishing agent, while the Spray Mode offers extensive coverage. Modes can be easily switched using a lever.

Scan the QR code to know more about the product



# TECHNICAL SPECIFICATIONS

Nomenclature	Action-Pac Fire Extinguisher Watermist 13 Ltr SS SP Red	Action-Pac Fire Extinguisher Foammist 13 Ltr SS SP Red
Stored Pressure/Cartridge	Stored Pressure	Stored Pressure
Product Code	CF-000642	CF-000679
Agent	Water	Water + 1% Foaming Agent
Throw up to (approx.)	Jet - 6 meters   Spray - 3 meters	Jet - 6 meters   Spray - 3 meters
Certification Standards	PED	PED
CE	Yes	Yes
UKCA	Yes	Yes
Gross Weight (approx.)	37.48 kg	37.48 kg
Net Mass (approx.)	13 Ltr	13 Ltr
Discharge Mechanism	Trigger Operated Gun	Trigger Operated Gun
Fire Ratings	27A*	5A, IVB
Can Construction	Drawn Rolled & MIG Welded	Drawn Rolled & MIG Welded
Valve/Cap Construction	Machining	Machining
External Coating	Epoxy Polyester Powder	Epoxy Polyester Powder
Operating Temp.	+5°C to +60°C	+5°C to +60°C
Min. Discharge Time	6 sec	6 sec
Throw up to (approx.)	Jet - 6 meters   Spray - 3 meters	Jet - 6 meters   Spray - 3 meters
Warranty in Years	5	5
Working Pressure	15 Bar	15 Bar
Height of Fire Ext. (approx)	485 mm	485 mm
Dia. of Shell (OD)	108 mm	108 mm
Hydrostatic Test Pressure	35 Bar	35 Bar
Body Thickness	1.5 mm	1.5 mm

\* Rating is self-verified.

FEATURING

# CEASEFIRE CAFS

## WATERMIST BASED COMPRESSED AIR FOAM SYSTEM - LOW PRESSURE

Water's immense firefighting power can be optimally utilised only by complete vaporisation in a fire environment. To achieve this, water must be broken down into microscopic molecules that have a surface area coverage many times higher than water.

These droplets (about 80 microns in size) must then be delivered to the fire with a kinetic force strong enough to overcome fire's own convection currents. The result: A powerful, reliable, efficient extinguisher.

Ceasefire now brings together all these features and creates Watermist Compressed Air Foam System; the best firefighting weapon ever designed.

Tested by **bsi.**



FIGHTS CLASS

A B ⚡

CERTIFICATIONS



## ADDING THAT EXTRA POWER WHEN YOU NEED IT THE MOST.

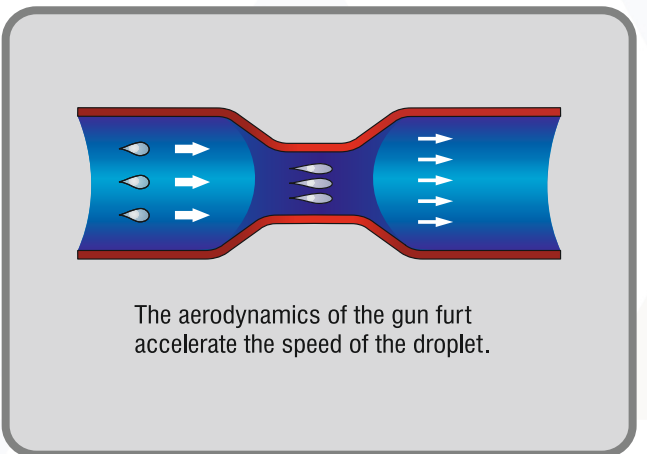
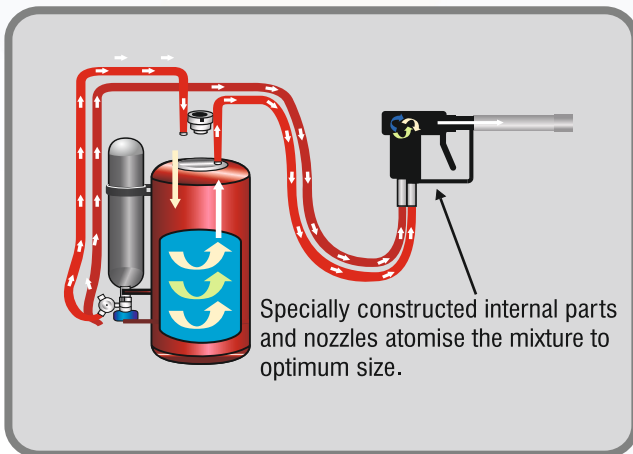
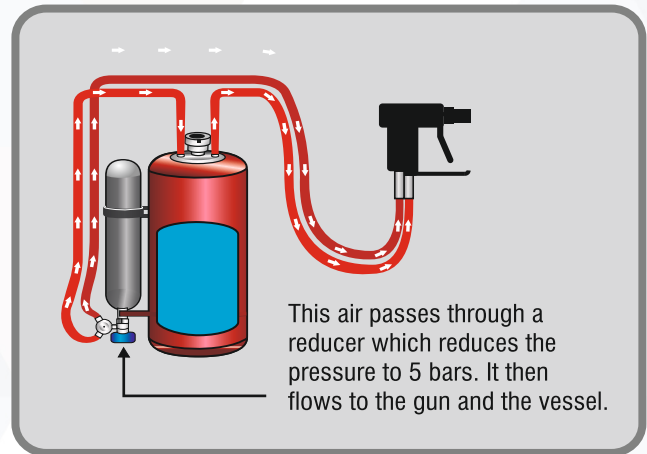
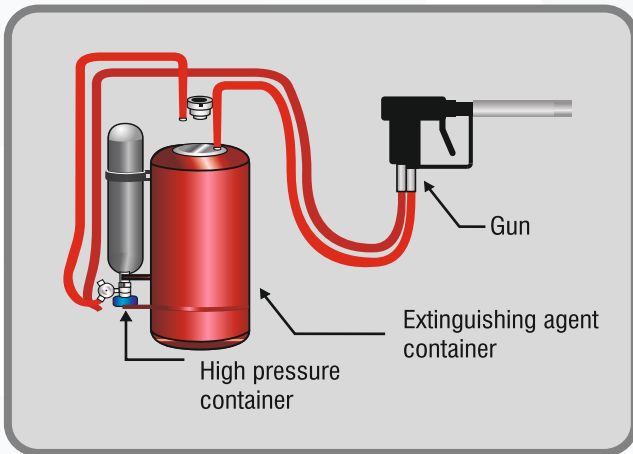

## THE DOUBLE PHASE EXTINGUISHING GUN WITH ADJUSTABLE NOZZLE



Spray Mode

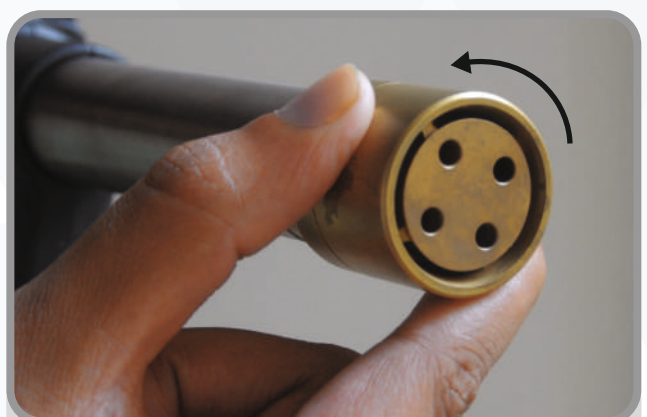

Jet Mode



## FEATURES & BENEFITS OF CAFS EXTINGUISHERS



### High Firefighting Effectiveness

Thanks to a vast evaporation surface, nearly 100% of the mist delivered through the Ceasefire Foam Mist System evaporates and engulfs the fire, making for a more powerful and efficient extinguisher.



### Extra Security For People-Screening

Mist acts as a great barrier against thermal radiation, giving added protection to the firefighter.



### Available in 2 Variants

CAF Low Pressure is available in 9 ltr Backpack and 50 ltr Trolley mounted variants to suit every kind of application.



### Types Of Fire

Fights class A, B, & Electrically Started Fires.



### Post-Fire Damage Reduction

About 80% of the damage resulting from a fire is actually caused by the extinguishing action: flooding and contamination with foam or active chemical extinguishing powder. Mist evaporates completely, causing little or no collateral damage.



### Warranty

These Ceasefire Extinguishers come with a 5-year warranty ensuring complete peace of mind.

Scan the QR code to know more about the product



# TECHNICAL SPECIFICATIONS

Nomenclature	CAFS Fire Extinguisher Foammist 9 Ltr SS CT Red Low Pressure	CAFS Fire Extinguisher Foammist 50 Ltr SS CT Red Low Pressure
Stored Pressure/Cartridge	Cartridge	Cartridge
Product Code	CF-000781	CF-000782
Agent	AFFF Foam 6%	AFFF Foam 6%
Throw (min.)	12 meters	16 meters
Certification Standards	PED, BSI Tested*	BS EN1866, PED
Kitemark	No	Yes
CE	Yes	Yes
UKCA	Yes	Yes
Gross Weight (approx.)	24.80 kg	102.50 kg
Net Mass (approx.)	9 Ltr	50 Ltr
Discharge Mechanism	Trigger Operated Gun	Trigger Operated Gun
Fire Ratings	27A, 233B	21A, IIB
Can Construction	Deep Drawn & MIG Welded	Drawn Rolled & MIG Welded
Valve/Cap Construction	Machining	Machining
External Coating	Epoxy Polyester Powder	Epoxy Polyester Powder
Operating Temp.	+5°C to +60°C	+5°C to +60°C
Min. Discharge Time	40 to 42 sec	120 sec
Warranty in Years	5	5
Working Pressure	8 Bar	8.5 Bar
Height of Fire Ext. (approx)	575 mm	1200 mm
Dia. of Shell (OD)	204 mm	300 mm
Hydrostatic Test Pressure	35 Bar	35 Bar
Body Thickness	1.5 mm	2 mm

\* Certificate awaited.

FEATURING

# CEASEFIRE QUAD

## WATERMIST & FOAM MIST WHEELED EXTINGUISHERS

Portable powder-based extinguishers on premises can fight the flames if the fire is detected early but have little capacity to fight large fires that might happen onboard. That's where Ceasefire's watermist & foam mist-based Quad comes in, to make the floating vessels completely self-reliant in terms of fire fighting. With sizes starting from 25, 50, and 100 Ltr., they bring in massive capacities onboard ships to fight any long battle against fire.

A power-packed Watermist or Watermist + Foam-based system, that takes firefighting up many notches. Approximately 400 times.



FIGHTS CLASS

A B ⚡

CERTIFICATIONS



## THE FUNCTIONALITY OF THE CEASEFIRE QUAD

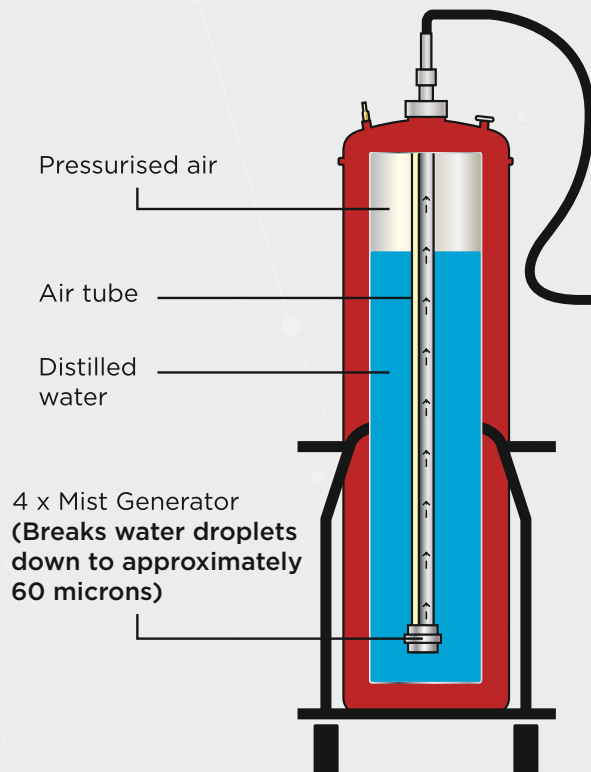

Named after the four state-of-the-art Multi-Rotors working in sync in each container, the Ceasefire Quad brings together the efficiency of a fire extinguisher with the power of a hydrant system – without the drawbacks.

Discharge gun



Mist (60 microns)

The Quad's Multi-Rotors, located within the mist generator, work in tandem, mixing water and air in a pre-set proportion to generate Watermist in the specially designed discharge gun. Thereby increasing the power of water by 400 times! It's the first time this revolutionary technology is available in a portable form with huge throw. Making the Quad truly state-of-the-art.

Meant for areas where fire risk is huge, or where large amount of combustible materials are stored, the wheel-mounted Quad can be taken anywhere with ease.

>>



## THE DISCHARGE GUN

The Ceasefire Quad fights fires with a lightweight dual-mode gun.



**The Jet Mode** of the gun enables the firefighter to deliver large quantities of extinguishing agent into the fire zone from a distance to subdue the fire.



**The Spray Mode** offers extensive coverage and protection against radiant heat when the firefighter approaches near to the fire zone. Modes can be easily switched using a lever.

The 5 metre EPDM hose pipe, with throw of 14-16 metres, adds to the Quad's firefighting effectiveness. Allowing the firefighter to maintain a safe distance from the raging fire. The Quad ensures zero risk of thermal shock and offers protection against fire's intense heat. What's more, it is safe to use on any fire, including electric, thanks to its sub-80 micron mist.



## THE QUAD AS A WATERMIST BASED SYSTEM

Though water is one of the most potent fire extinguishing agent around, large quantities are required to extinguish a fire. Harnessing water's immense cooling powers and multiplying them hundreds of times over, Ceasefire's Watermist technology breaks water down into a fine mist of under 80 microns. This mist is then thrown at the fire with a great kinetic force, covering a large

surface area. As soon as the mist comes into contact with the fire, it instantly turns into steam. Enveloping the flames, cutting down the oxygen supply and reducing temperature to below combustion levels. Powered by Watermist, the Ceasefire Quad is unstoppable. Equipped with four Multi-Rotors in each container, it's fully capable of generating Watermist quickly and efficiently.

Water breaks down into a fine mist of under 80 microns.

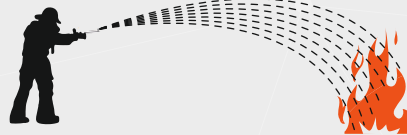
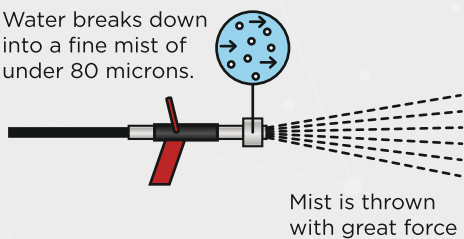

Mist turns into steam, covering the flames and lowering the temperature

## THE QUAD AS A FOAMMIST BASED SYSTEM:

The quickest way to kill a fire is to not let it feed on the oxygen in the vicinity. When used as a Foammist System, the Ceasefire Quad blankets the flames with an environmentally safe foam that's highly effective on Class B

fires, oil and petrol fires. With a sub-80 micron size mist, the Quad ensures there's no risk of electric conduction, thermal shock or recoil while operating.

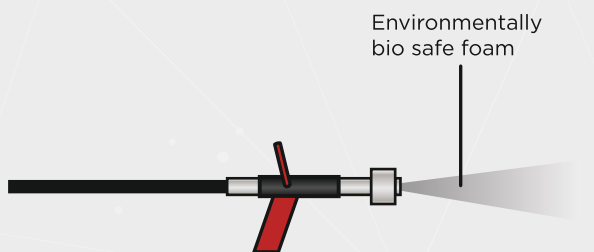

Highly effective on oil and petrol fires

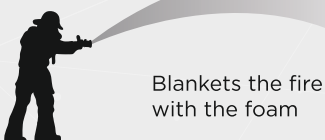

# FEATURES & BENEFITS OF QUAD WHEELED TYPE EXTINGUISHERS



## Jet And Spray Modes\*

With a throw of 14-16 metres, the Wheeled Watermist-Based System comes with two firefighting options. The Jet Mode of the gun enables the firefighter to deliver large quantities of extinguishing agent into the fire zone from a distance to subdue the fire. The Spray Mode offers extensive coverage and protection against radiant heat when the firefighter approaches the fire zone. Modes can be easily switched using a lever.



Jet  
Mode

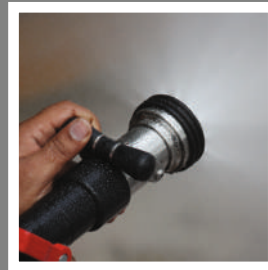

Spray  
Mode

\* The dual-mode gun in Quad is available only in CE-certified models.



## Easy To Use With Quick Activation

Being a stored pressure extinguisher, the system requires no cartridge system (internal or external) activation. It's always ready. Simply press the trigger to activate.



## Maintenance By Mere Observation Of The Pressure Gauge

If the pressure needle is in the green zone, it indicates that the extinguisher is in perfect working condition, and all the components are at their optimum.



## Does Not Require Any Electricity

It's always ready to fight the flames. As it does not depend on electricity.



## Types Of Fire

Fights class A, B & Electrically Started Fires.



## Tamper-proof Safety Seal

This seal ensures that the extinguisher has not been tampered with, and is ready for use in the event of a fire.



## Warranty

These Ceasefire Extinguishers come with a 5-year warranty ensuring complete peace of mind.



## Every Extinguisher Is Hydrostatic Pressure Tested

This process ensures that your system performs perfectly. Because when it comes to fire, there are no second chances.



## Low Pressure, Safe Technology

Being a low pressure extinguisher, there are no risks involved in case the extinguisher is used by mistake, even if people are around.



## Wheeled Base, Therefore Portable

Can be easily carried or wheeled to the scene of fire without any delay.



## EPDM Rubber Hosepipe

This durable, long-lasting pipe doesn't develop any cracks under normal wear and tear conditions.



### Safe To Use On Electrical Fires

Suitable for use on live electrical equipment up to 1000 V from a distance of 1 meter.



### Stainless Steel Body

The extinguisher's stainless steel body ensures that there is no chance of corrosion.



### Safe on Humans

Being a watermist based system, it can safely be used around people. It makes an ideal extinguisher for places where there is high human traffic, like cinemas and auditoriums.



### Environment Friendly

It uses biodegradable foam and water to fight fires. Making it an extinguisher that also protects the earth.



### Anti-bacterial Additive

This additive prevents any kind of bacterial growth in the water, keeping the water clean and fresh.



Scan the QR code to know more about the product



# TECHNICAL SPECIFICATIONS

## WATERMIST

Nomenclature	Fire Ext. Watermist 25 Ltr SS SP Red with Trolley	Fire Ext. Watermist 50 Ltr SS SP Red with Trolley	Fire Ext. Watermist 100 Ltr SS SP Red with Trolley
Stored Pressure/Cartridge	Stored Pressure	Stored Pressure	Stored Pressure
Product Code	CF-000741	CF-000742	CF-000743
Agent	Water	Water	Water
Certification Standards	BS EN1866, PED, EU-MED, UKCA-MER	BS EN1866, PED, EU-MED, UKCA-MER	BS EN1866, PED, EU-MED, UKCA-MER
LPCB	Yes	Yes	Yes
Kitemark	Yes	Yes	Yes
EU-MED	Yes	Yes	Yes
UKCA-MER	Yes	Yes	Yes
CE	Yes	Yes	Yes
UKCA	Yes	Yes	Yes
Gross Weight (approx.)	65 kg	106.80 kg	166.20 kg
Net Mass (approx.)	25 Ltr	50 Ltr	100 Ltr
Discharge Mechanism	Operating Lever (Ball Valve)	Operating Lever (Ball Valve)	Operating Lever (Ball Valve)
Fire Ratings	A	A	A
Can Construction	Drawn Rolled & MIG Welded	Drawn Rolled & MIG Welded	Drawn Rolled & MIG Welded
Valve/Cap Construction	Forging & Machining	Forging & Machining	Forging & Machining
External Coating	Epoxy Polyester Powder Coating	Epoxy Polyester Powder Coating	Epoxy Polyester Powder Coating
Operating Temp.	+5°C to +60°C	+5°C to +60°C	+5°C to +60°C
Average Discharge Duration as per - EN 1866 Clause 8.2.2	20 sec	40 sec	80 sec
Throw (min.)	4 meters	4 meters	4 meters
Warranty in Years	5	5	5
Working Pressure	15 Bar	15 Bar	15 Bar
Height of Fire Ext. (approx)	1075 mm	1200 mm	1615 mm
Dia. of Shell (OD)	300 mm	350 mm	400 mm
Hydrostatic Test Pressure	30 Bar	30 Bar	30 Bar
Body Thickness	1.8 mm	2 mm	2 mm

# TECHNICAL SPECIFICATIONS

## (FOAM MIST)

Nomenclature	Fire Ext. Foammist 25 Ltr SS SP Red with Trolley	Fire Ext. Foammist 50 Ltr SS SP Red with Trolley	Fire Ext. Foammist 100 Ltr SS SP Red with Trolley
Stored Pressure/Cartridge	Stored Pressure	Stored Pressure	Stored Pressure
Product Code	CF-000744	CF-000745	CF-000746
Agent	Telesolve 1%	Telesolve 1%	Telesolve 1%
Certification Standards	BS EN1866, PED, EU-MED, UKCA-MER	BS EN1866, PED, EU-MED, UKCA-MER	BS EN1866, PED, EU-MED, UKCA-MER
LPCB	Yes	Yes	Yes
Kitemark	Yes	Yes	Yes
EU-MED	Yes	Yes	Yes
UKCA-MER	Yes	Yes	Yes
CE	Yes	Yes	Yes
UKCA	Yes	Yes	Yes
Gross Weight (approx.)	66.50 kg	107.50 kg	166.70 kg
Net Mass (approx.)	25 Ltr	50 Ltr	100 Ltr
Discharge Mechanism	Operating Lever (Ball Valve)	Operating Lever (Ball Valve)	Operating Lever (Ball Valve)
Fire Ratings	A, IVB	A, IVB	A, IVB
Can Construction	Drawn Rolled & MIG Welded	Drawn Rolled & MIG Welded	Drawn Rolled & MIG Welded
Valve/Cap Construction	Forging & Machining	Forging & Machining	Forging & Machining
External Coating	Epoxy Polyester Powder Coating	Epoxy Polyester Powder Coating	Epoxy Polyester Powder Coating
Operating Temp.	+5°C to +60°C	+5°C to +60°C	+5°C to +60°C
Average Discharge Duration as per - EN 1866 Clause 8.2.2	20 sec	40 sec	80 sec
Throw up to (approx.)	10 meters	10 meters	10 meters
Warranty in Years	5	5	5
Working Pressure	15 Bar	15 Bar	15 Bar
Height of Fire Ext. (approx)	1075 mm	1200 mm	1615 mm
Dia. of Shell (OD)	300 mm	350 mm	400 mm
Hydrostatic Test Pressure	30 Bar	30 Bar	30 Bar
Body Thickness	1.8 mm	2 mm	2 mm

FEATURING

# CEASEFIRE TETRAQUAD

## THE 4X4 WATERMIST FIREFIGHTER.

Presenting for the first time time, the Ceasefire TetraQuad. A power-packed Watermist + Foam-based system that takes firefighting up 4x4. It is Ceasefire's, biggest and toughest standalone firefighter to date.

The TetraQuad takes the power of the Quad four times ahead. Named after the four state-of-the-art multi-rotors working in sync in each of the four 62.5 Ltr. containers (250 Ltr. capacity), the Ceasefire TetraQuad brings together the efficiency of a fire extinguisher with the power of a hydrant system – without the drawbacks.

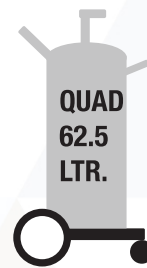

X 4 = 250 LTR.

FIGHTS CLASS

A B

CERTIFICATIONS

CE 1128 UK CA

# THE FUNCTIONALITY OF THE CEASEFIRE TETRAQUAD

The TetraQuad's Multi-Rotors, located within the mist generator, work in tandem, mixing water and air in a pre-set proportion to generate Watermist in the specially designed discharge gun. Thereby increasing the power of water by 400 times! Making the TetraQuad truly a state-of-the-art protector.

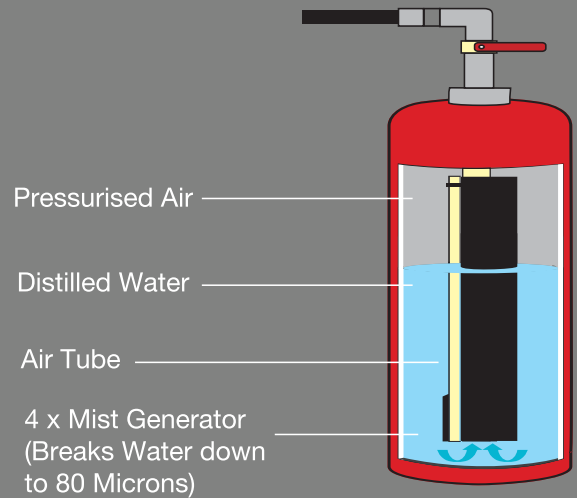
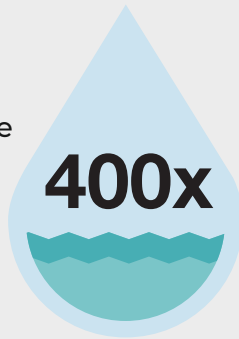

## THE 3-DISCHARGE GUN

The Ceasefire TetraQuad fights fires with a lightweight dual-mode gun or a foam canon.



**The Jet Mode** of the dual-mode gun enables the firefighter to deliver large quantities of extinguishing agent into the fire zone from a distance to subdue the fire.



**The Spray Mode** offers extensive coverage and protection against radiant heat when the firefighter approaches the fire zone. Modes can be easily switched using a lever.



**The Foam Cannon** is perfect for Class B fires. Offering a huge throw, it dispenses large quantities of foam over the fire quickly and efficiently.

# A COMPLETE FIREFIGHTING MACHINE

## The TetraQuad as a Watermist-based System

Powered by Watermist, the TetraQuad can take on any fire. Equipped with four Multi-Rotors in four containers, it's fully capable of generating Watermist quickly and efficiently. Available as trolley-mounted or vehicle-mounted system, it's truly an unstoppable 4x4 firefighter.



## The TetraQuad as a Watermist + Foam mist-based System

The quickest way to kill a fire is to not let it feed off the oxygen in the vicinity. When used as a Foam System, the Ceasefire TetraQuad blankets the flames with a special foam that's highly effective on Class B fires, and oil and petrol fires. With a sub-70 micron size mist, the TetraQuad ensures there's no risk of electric conduction, thermal shock or recoil while operating.

## The TetraQuad as a Foam-based System

In large fires involving petrol pumps, you need to go foam. With a range of 30 metres and a 60 second discharge, the TetraQuad floods the area with thick foam, immediately cutting off the oxygen supply and giving the fire only one choice - to go out.

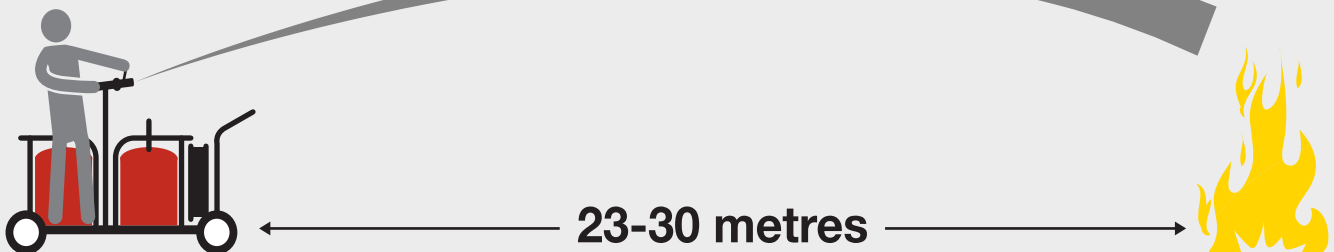

# FEATURES & BENEFITS OF TETRAQUAD WHEELED TYPE EXTINGUISHERS



## Easy To Use With Quick Activation

Being a stored pressure extinguisher, the TetraQuad requires no cartridge system (internal or external) activation. It's always ready. Simply press the trigger to activate.



## Controllable Discharge Mechanism

The Ceasefire TetraQuad fights fires with a lightweight Dual-mode Gun or a Foam Cannon, with a massive 30 metre throw.



## Long Hose

The TetraQuad's 30 metre hose makes firefighting easy, allowing firefighters to manoeuvre their way towards the fire, point the hose and fight the flames. This durable, long-lasting, Nylon braided rubber hose pipe doesn't develop any cracks due to wear and tear.



## Safe On Humans

Since the TetraQuad uses Watermist to suppress fires, it can safely be used around people. It is an ideal extinguisher for places where there is high human traffic, like cinemas and auditoriums. It also protects against thermal shock.



## Does Not Require Any Electricity

The TetraQuad doesn't require any electricity to function. It's always ready to fight the flames.



## Types Of Fire

The TetraQuad is a massive firefighting system effective against class A and B fires.



## Environment-friendly

As a Watermist system, the TetraQuad also protects the Earth.



## Wheeled Extinguisher

Can be easily rushed to the scene of fire without any delay.



## Stainless Steel Body

The extinguisher's stainless steel body ensures that there is no chance of corrosion.



## 4 Cylinders, Massive Firefighting

The TetraQuad has four 62.5 litre cylinders. That's 250 litres of humongous firefighting power at its disposal!



## Maintenance By Mere Observation Of The Pressure Gauge

If the pressure needle is in the green zone, it indicates that the extinguisher is in perfect working condition, and all the components are at their optimum.



## Low Pressure, Safe Technology

Being a low pressure system, there are no risks involved in case the extinguisher is used by mistake, even if people are around.

Scan the QR code to know more about the product



# TECHNICAL SPECIFICATIONS

Nomenclature	Tetraquad Fire Extinguisher 250 Ltr SS SP Red	Tetraquad Fire Extinguisher 250 Ltr SS SP Red Additive
Stored Pressure/Cartridge	Stored Pressure	Stored Pressure
Product Code	CF-000860	CF-000861
Agent	Water	Water + 6% of KV Lite Foam 3% C-6
Throw (min.)	Jet Mode : 20 meters   Spray Mode : 4 Meters	Jet Mode : 20 meters   Spray Mode : 4 Meters
Certification Standards	PED	PED
Kitemark	No	Yes
PED	Yes	Yes
UKCA-PED	Yes	Yes
Gross Weight (approx.)	500 kg	500 kg
Net Mass (approx.)	250 Ltr	250 Ltr
Discharge Mechanism	Operating Lever (Ball Valve)	Operating Lever (Ball Valve)
Can Construction	Drawn Rolled & MIG Welded	Drawn Rolled & MIG Welded
Valve/Cap Construction	Forging & Machining	Forging & Machining
External Coating	Epoxy Polyester Powder	Epoxy Polyester Powder
Operating Temp.	+5°C to +60°C	+5°C to +60°C
Min. Discharge Time	100 to 200 sec	100 to 200 sec
Warranty in Years	1	1
Working Pressure	12 to 15 Bar	12 to 15 Bar
Dia. of Shell (OD)	450 mm	450 mm
Hydrostatic Test Pressure	30 Bar	30 Bar
Body Thickness	2.5 mm	2.5 mm



## **CEASEFIRE CLASSICS**

**BUILT FOR SPEED, POWER, AND  
RELIABILITY**

## HOME AND CAR FIRE EXTINGUISHERS (CLASSIC RANGE)

### OVERVIEW:

Ceasefire's range of Home & Car extinguishers take the guesswork and confusion out of choosing an extinguisher and save valuable time. Mono Ammonium Phosphate being a potent firefighting agent maximises the fire fighting power. These extinguishers are easier to use than others because of their lightweight 'point and shoot' design.

### FEATURES:

- Most potent against Home & Car fires.
- Simplicity in design.
- Portable and easy to use.
- Colors to suit your home decor.
- State-of-the-art pressure gauge.
- Easy snap safety seal.
- World-class quality.



### QUICK SPECS:

Sizes	500 gms, 1 kg
Agents	MAP 50, MAP 90
Colors	Red, Ivory, Blue, Silver
Pressure Type	Stored Pressure
Warranty	5 years

#### FIGHTS CLASS



#### CERTIFICATIONS



Scan the QR code to know more about the product



## HOME AND CAR FIRE EXTINGUISHERS (ART RANGE)

### OVERVIEW:

Designed to match the aesthetics of your home, so that it is easily accessible in an emergency. Ceasefire's Designer range of extinguishers are art installations of fine steel and ink, crafted to meet international standards and designed to exceed them. Making these extinguishers true works of art. Art that saves property and lives.

### FEATURES:

- Most potent against Home & Car fires.
- Simplicity in design.
- Portable and easy to use.
- Colors to suit your home decor.
- State-of-the-art pressure gauge.
- Easy snap safety seal.
- World class quality.



### QUICK SPECS:

Sizes	500 gms, 1 kg
Agents	MAP 90
Pressure Type	Stored Pressure
Warranty	5 years
Design	Hexalight, Kiterunner, Waves, Elasticity

Scan the QR code to know more about the product



#### FIGHTS CLASS



#### CERTIFICATIONS



## ABC POWDER PORTABLE & WHEELED EXTINGUISHERS

### OVERVIEW:

In environments such as schools, offices, hospitals & factories, the Ceasefire ABC Powder extinguisher is your safest bet. Mono Ammonium Phosphate paired with a simple, controllable discharge mechanism maximises the firefighting power and puts out the fire within seconds.

### FEATURES:

- Fights Class A, B, C and Electrically started fires.
- Packed with 50% and 90% MAP concentration.
- State-of-the-art Pressure Gauge.
- Quick, powerful and reliable firefighting system.
- Equipped with Schraeder Valve and Pressure Relief Valve (available only in portable range).
- Glow-in-the-Dark Label for easy visibility and quick access even in complete darkness.



### QUICK SPECS:

Sizes - Portable	2 kg, 4kg, 6 kg, 9 kg, 12 kg
Sizes - Wheeled	25 kg, 50 kg, 100 kg
Agents	MAP 50, MAP 90
Working Pressure	15 Bar
Pressure Type	Stored Pressure
Warranty	5 years

Scan the QR code to know more about the product

ABC Powder  
Portable



ABC Powder  
Wheeled



## CO<sub>2</sub> PORTABLE & WHEELED EXTINGUISHERS

### OVERVIEW:

Ceasefire's sturdy and light CO<sub>2</sub> extinguisher is very effective in putting out fires in larger spaces. Packed with tremendous power, it reduces the fire's oxygen supply, and brings the temperature down drastically, extinguishing the flames in seconds.

### FEATURES:

- Fights Class B, C and Electrically started fires.
- Advanced horn to dispense gas, removes risk of freeze burn.
- State-of-the-art Used/Ready indicator in selected range.



### QUICK SPECS:

Sizes - Portable	2 kg, 5 kg
Sizes - Wheeled	20 kg
Agent	Co2
Working Pressure	70 Bar / 62 bar
Pressure Type	Stored Pressure
Warranty	5 years

Scan the QR code to know more about the product



## WATER PORTABLE & WHEELED EXTINGUISHERS (JET MODEL)

### OVERVIEW:

Water has always been fire's deadliest foe. Ceasefire's Water extinguisher uses proprietary Stored Pressure Technology to deliver a high power throw of water. This ensures it fights fires effectively and enables the firefighter to maintain a safe distance from the flames.

### FEATURES:

- Fights Class A fires.
- EPDM / Braided Rubber Hosepipe.
- Easy Snap Safety Pin.
- State-of-the-art Pressure Gauge in portable range.
- Powder Coated cylinder liner.
- Deep Drawn Body in the portable range.
- Extinguishant dispersed via specially designed Jet Nozzle.
- Equipped with Schraeder Valve and Pressure Relief Valve (available only in portable range).
- Glow-in-the-Dark Label for easy visibility and quick access even in complete darkness.



### QUICK SPECS:

Sizes - Portable	6 Ltr, 9 Ltr
Sizes - Wheeled	50 Ltr, 100 Ltr
Agent	Water
Color	Red & Chrome Finish
Working Pressure	10 Bar
Pressure Type	Stored Pressure
Warranty	5 years

#### FIGHTS CLASS

A

#### CERTIFICATIONS



Scan the QR code to know more about the product

Water Portable



Water Wheeled



## FOAM PORTABLE & WHEELED EXTINGUISHERS (ASPIRATING MODEL)

### OVERVIEW:

Fire needs oxygen to grow. Without it, even the largest fires die out in minutes. Ceasefire's Foam extinguisher exploits this weakness by discharging a mechanical foam that blankets the flames and cuts off the oxygen supply. It's what we like to call simple and effective firefighting.

### FEATURES:

- Fights Class A and B fires.
- State-of-the-art Pressure Gauge in portable range.
- Deep Drawn Body in the portable range.
- Stored Pressure technology for more effective firefighting.
- Squeeze Grip mechanism for quick and easy use.
- Equipped with Schraeder Valve and Pressure Relief Valve (available only in portable range).
- Glow-in-the-Dark Label for easy visibility and quick access even in complete darkness.



### QUICK SPECS:

Sizes - Portable	3 Ltr, 6 Ltr, 9 Ltr
Sizes - Wheeled	50 Ltr, 100 Ltr
Agent	Water + 6% of KV Foam 3% C-6
Color	Red & Chrome Finish
Working Pressure	15 Bar
Pressure Type	Stored Pressure
Warranty	5 years

#### FIGHTS CLASS

A B

#### CERTIFICATIONS



Scan the QR code to know more about the product

Foam  
Portable



Foam  
Wheeled



## WET CHEMICAL PORTABLE EXTINGUISHERS

### OVERVIEW:

Designed to fight kitchen oil and fat fires, Ceasefire's Wet Chemical fire extinguisher uses an environmental friendly foaming agent that blankets the flames, cuts off the supply of oxygen and cools the oil to below the self-ignition point.

### FEATURES:

- Biodegradable extinguishing agent.
- Reduces risk of re-ignition.
- Epoxy polyester powder coated internal container lining.
- Suitable for use on live electrical equipment upto 1000 V from a distance of 1 meter.
- Glow-in-the-Dark Label for easy visibility and quick access even in complete darkness.



### QUICK SPECS:

Sizes - Portable	3 Ltr, 6 Ltr, 9 Ltr
Agent	KV Lite 100% Class K Foam
Color	Red & Chrome Finish
Working Pressure	15 Bar
Pressure Type	Stored Pressure
Warranty	5 years

#### FIGHTS CLASS

A F ⚡

#### CERTIFICATIONS



Scan the QR code to know more about the product



## B PLUS (CLASS B) EXTINGUISHERS

### OVERVIEW:

Ceasefire's B Plus is the perfect extinguisher for petrol stations and petrochemical plants. It is ideal for Class B and C fires involving gasoline, alcohol, industrial chemicals, and more. When activated, its unique powder splits into four, covering a large surface area. So when faced with a high risk of class B fires like petrol, diesel, etc. You go for B Plus.

### FEATURES:

- Unique powder splits into four upon activation.
- High power agent throw covers a huge surface area.
- Equipped with Schraeder Valve and Pressure Relief Valve.
- Glow-in-the-Dark Label for easy visibility and quick access even in complete darkness.



#### FIGHTS CLASS



#### CERTIFICATIONS



Scan the QR code to know more about the product



### QUICK SPECS:

Sizes	2 kg, 4 kg, 6 kg, 9 kg
Agent	B Plus Powder
Working Pressure	15 Bar
Pressure Type	Stored Pressure
Warranty	5 years

## METAL FIRE EXTINGUISHERS

### OVERVIEW:

Industries that work with metals such as magnesium, potassium, sodium, titanium, uranium and calcium are at a high risk of fire. Using the wrong extinguishing agent in this case may cause more damage. The Ceasefire SPM-TEC and SPM-PYRO are ideal combatants against fires involving heavy metals, alkali metals and their alloys. They are powerful enough to stop metal fires of up to 5000°C. Dead in their tracks. Within minutes.

### FEATURES:

- Deep drawn mild steel container.
- Powder Coated cylinder liner.
- Special Cascade Nozzle to aid effective agent dispersal over fire.

SPM-TEC effectively fights light metal fires like

- Magnesium (Mg), Lithium (Li), Sodium (Na), Potassium (K), etc. which produce heat up to 2000°C.

SPM-PYRO effectively fights heavy metal fires like

- Plutonium (Pl), Titanium (Ti), Lead (Pb), Zinc (Zn), Copper (Cu), etc. which produces heat up to 5000°C or above.

Glow-in-the-Dark Label for easy visibility and quick access even in complete darkness.



### QUICK SPECS:

Sizes	4 kg, 6 kg, 9 kg
Agent	SPM-TEC, SPM-PYRO
Working Pressure	15 Bar
Pressure Type	Stored Pressure
Warranty	5 years

#### FIGHTS CLASS



#### CERTIFICATIONS



Scan the QR code to know more about the product

SPM - TEC



SPM - PYRO





## CEASEFIRE ACCESSORIES

GIVING EXTINGUISHERS THE PLACE THEY DESERVE

## STROLLEYS

### OVERVIEW:

Fires can happen anywhere and at any time. Which makes it important to install extinguishers in relevant places. But, what happens when a fire breaks out and the equipment is not easy to ferry around? Ceasefire presents the perfect accessory to mobilise your fire fighting equipment. Our range of innovative fire extinguisher strolleys are capable of carrying one or two extinguishers. Think of them as life savers on wheels.

### FEATURES:

- High quality construction for easy mobility.
- Retractable handles.
- Photo luminescent signs for visibility through smoke and darkness.
- Powder-coated, rustproof bodies.
- Available in Single Type & Double Type.

Scan the QR code to know more about the product



### QUICK SPECS:

Single Extinguisher Strolley	320 x 290 x 750 mm
Double Extinguisher Strolley	620 x 520 x 1150 mm



## FLAT PACK TUBULAR EXTINGUISHER STANDS (CHROME FINISH)

### OVERVIEW:

An aesthetically pleasing design that epitomises functionality, these Fire Extinguisher Stands in Chrome finish are an ideal choice for most spaces. The stands come with a CO<sub>2</sub> fixing bracket and a J-bracket for easy and steady installation along with a provision to attach a sign clip for extinguisher identification.

### FEATURES:

- High quality tubular frame in chrome finish.
- Tubing diameter of 25mm.
- Black plastic stand ensure stands sit firmly at their place.
- Comes in a box packaging for ease of transit and storage.
- Easy to assemble.
- Available in Single, Double, and Triple extinguisher stand variants.
- Available in Chrome Finish.

### QUICK SPECS:

Single Extinguisher Stand	H735 x L325 x B300 mm   weight - 2.8 kg
Double Extinguisher Stand	H737 x L560 x B300 mm   weight - 4.9 kg
Triple Extinguisher Stand	H737 x L705 x B300 mm   weight - 6.44 kg



## PROVISION FOR ACCESSORIES

The stands comes with a provision to add a placard and a clip for mounting of signage. For details on the signages available please refer to the Signages section under Accessories.



## PACKAGING DIMENSIONS



Product	Dimensions
Single Extinguisher Stand	H70 x L710 x B320 mm
Double Extinguisher Stand	H70 x L715 x B505 mm
Triple Extinguisher Stand	H70 x L715 x B650 mm

Scan the QR code to know more about the product



## SIGNAGES

### OVERVIEW:

Did you know that the majority of the fires start in electrical mains, or because of an electrical short circuit? And even those fires that start elsewhere may, eventually result in a failure of electricity, because of damage to the mains and wiring. Which means that in a fire situation, you can be sure that at some point, the entire premises will be plunged into darkness.

Noxious black smoke will fill the air, increasing the risk of asphyxiation for all in the area. A frightening scenario when you consider the fact that asphyxiation and smoke poisoning are the highest causes of casualties in any fire. Darkness and poisonous smoke. A sure recipe for panic and utter chaos.

In such a situation, the single most important need of the hour is to evacuate all those on the premises to the nearest point of safety. As efficiently and quickly as possible. And Ceasefire, quite literally, shows you the way.



## Fire action

if you discover a fire

	Operate nearest fire alarm point.
	Call the Fire brigade by telephoning <span style="border: 1px solid white; padding: 0 5px;">  </span> 999
	Leave the building by the nearest exit.
	Report to your assembly point at <span style="border: 1px solid white; padding: 0 5px;">  </span>
	Do not stop to collect personal belongings.
	Do not use lift.

### FIRE SAFETY SIGNS

Locator signs, fire extinguisher identification signs and more.





Safe for:  
Wood, paper  
and textiles. ✓



Not for:  
Flammable  
liquids.



Not for:  
Flammable  
metal fires.



Not for:  
Live electrical  
equipment.

Water

CEASE FIRE





Safe for:  
Wood, paper  
and textiles. ✓



Safe for:  
Flammable  
liquids. ✓



Safe for:  
Gaseous  
fires. ✓



Safe for:  
Live electrical  
equipment. ✓

ABC Powder

CEASE FIRE





Safe for:  
Wood, paper  
and textiles. ✓



Safe for:  
Flammable  
liquids. ✓



Not for:  
Flammable  
metal fires.



Not for:  
Live electrical  
equipment.

Foam

CEASE FIRE





Safe for:  
Wood, paper  
and textiles. ✓



Not for:  
Flammable liquids.



Not for:  
Flammable gases.



Not for:  
Live electrical  
equipment.



Safe for:  
Cooking oils  
and deep fat fires. ✓

Wet Chemical

CEASE FIRE

In case of a fire, the firefighting equipment on the premises needs to be located and activated quickly. Ceasefire Fire Safety Signs

help guide people to the nearest extinguishers, hosepipes, emergency alarms and so on.

**Fire Action**

1. Operate nearest fire alarm.
2. Leave building by the nearest exit.
3. Report to assembly point.

**CODE: CF-001522**  
**Size: 200 X 150 MM**

**Fire Action**

1. Operate nearest fire alarm.
2. Leave building by the nearest exit.
3. Report to assembly point.

**CODE: CF-001523**  
**Size: 300 X 250 MM**

**Fire action if you discover a fire**

- Operate nearest fire alarm point.
- Call the Fire brigade by telephoning 999
- Leave the building by the nearest exit.
- Report to your assembly point at \_\_\_\_\_
- Do not stop to collect personal belongings.
- Do not use lift.

**CODE: CF-001524**  
**Size: 200 X 150 MM**

**Fire action if you discover a fire**

- Operate nearest fire alarm point.
- Call the Fire brigade by telephoning 999
- Leave the building by the nearest exit.
- Report to your assembly point at \_\_\_\_\_
- Do not stop to collect personal belongings.
- Do not use lift.

**CODE: CF-001525**  
**Size: 300 X 250 MM**

**Fire action if you discover a fire**

- Operate nearest fire alarm point.
- Call the Fire brigade by telephoning 999
- Leave the building by the nearest exit.
- Report to your assembly point at \_\_\_\_\_
- Do not stop to collect personal belongings.

**CODE: CF-001526**  
**Size: 200 X 150 MM**

**Fire action if you discover a fire**

- Operate nearest fire alarm point.
- Call the Fire brigade by telephoning 999
- Leave the building by the nearest exit.
- Report to your assembly point at \_\_\_\_\_
- Do not stop to collect personal belongings.

**CODE: CF-001527**  
**Size: 300 X 250 MM**

**Fire action if you discover a fire**

- Operate nearest fire alarm point.
- Fire Brigade will be called automatically
- Leave the building by the nearest exit.
- Report to your assembly point at \_\_\_\_\_
- Do not stop to collect personal belongings.
- Do not use lift.

**CODE: CF-001528**  
**Size: 200 X 150 MM**

**Fire action if you discover a fire**

- Operate nearest fire alarm point.
- Fire Brigade will be called automatically
- Leave the building by the nearest exit.
- Report to your assembly point at \_\_\_\_\_
- Do not stop to collect personal belongings.
- Do not use lift.

**CODE: CF-001529**  
**Size: 300 X 250 MM**

**Fire action if you discover a fire**

- Operate nearest fire alarm point.
- Fire Brigade will be called automatically
- Leave the building by the nearest exit.
- Report to your assembly point at \_\_\_\_\_
- Do not stop to collect personal belongings.

**CODE: CF-001530**  
**Size: 200 X 150 MM**

**Fire action if you discover a fire**

- Operate nearest fire alarm point.
- Fire Brigade will be called automatically.
- Leave the building by the nearest exit.
- Report to your assembly point at \_\_\_\_\_
- Do not stop to collect personal belongings.

**CODE: CF-001531**  
**Size: 300 X 250 MM**

**Staff Fire Action Routine**

- Operate nearest fire alarm point.
- Call the Fire Brigade.
- Fight the fire, if safe and trained to do so.
- Evacuate the building via the nearest exit.
- Do not stop to collect personal belongings.

**CODE: CF-001532**  
**Size: 200 X 150 MM**

**Staff Fire Action Routine**

- Operate nearest fire alarm point.
- Call the Fire Brigade.
- Fight the fire, if safe and trained to do so.
- Evacuate the building via the nearest exit.
- Do not stop to collect personal belongings.

**CODE: CF-001533**  
**Size: 300 X 250 MM**



**CODE: CF-001513**  
**Size: 150 X 105 MM**

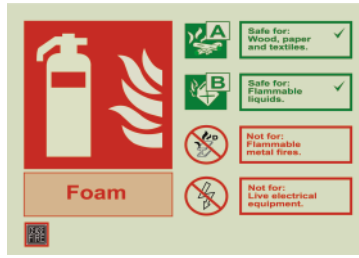

**CODE: CF-001514**  
**Size: 150 X 105 MM**



**CODE: CF-001515**  
**Size: 150 X 105 MM**

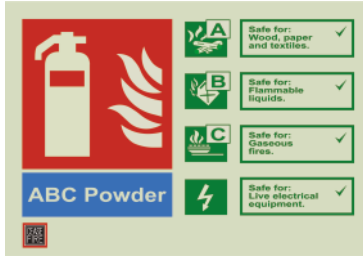

**CODE: CF-001516**  
**Size: 150 X 105 MM**



**CODE: CF-001517**  
**Size: 150 X 105 MM**



**CODE: CF-001518**  
**Size: 150 X 105 MM**



**CODE: CF-001519**  
**Size: 150 X 105 MM**

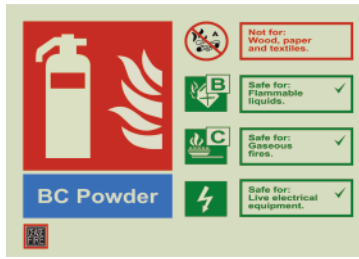

**CODE: CF-001520**  
**Size: 150 X 105 MM**



**CODE: CF-001521**  
**Size: 150 X 105 MM**



**CODE: CF-001724**  
**Size: 150 X 105 MM**





**Water**

	Safe for: Wood, paper and textiles. ✓
	Not for: Flammable liquids.
	Not for: Flammable metal fires.
	Not for: Live electrical equipment.

CODE: CF-001513V  
Size: 75 X 200 MM



**Foam**

	Safe for: Wood, paper and textiles. ✓
	Safe for: Flammable liquids. ✓
	Not for: Flammable metal fires.
	Not for: Live electrical equipment.

CODE: CF-001514V  
Size: 75 X 200 MM



**Carbon Dioxide**

	Not for: Wood, paper and textiles.
	Safe for: Flammable liquids. ✓
	Not for: Flammable metal fires.
	Safe for: Live electrical equipment. ✓

CODE: CF-001515V  
Size: 75 X 200 MM



**ABC Powder**

	Safe for: Wood, paper and textiles. ✓
	Safe for: Flammable liquids. ✓
	Safe for: Gaseous fires. ✓
	Safe for: Live electrical equipment. ✓

CODE: CF-001516V  
Size: 75 X 200 MM



**Wet Chemical**

	Safe for: Wood, paper and textiles. ✓
	Not for: Flammable liquids.
	Not for: Flammable gases.
	Safe for: Live electrical equipment. ✓
	Safe for: Cooking oils and deep fat fires. ✓

CODE: CF-001517V  
Size: 75 X 200 MM



**Water Mist**

	Safe for: Wood, paper and textiles. ✓
	Not for: Flammable liquids.
	Safe for: Live electrical equipment. ✓
	Safe for: Cooking oils and deep fat fires. ✓

CODE: CF-001518V  
Size: 75 X 200 MM



**Water Spray**

	Safe for: Wood, paper and textiles. ✓
	Not for: Flammable liquids.
	Safe for: Live electrical equipment. ✓
	Safe for: Cooking oils and deep fat fires. ✓

CODE: CF-001603V  
Size: 75 X 200 MM



**Multi Max L-Ion**

	Safe for: Wood, paper and textiles. ✓
	Safe for: Flammable liquids. ✓
	Safe for: Live electrical equipment. ✓
	Safe for: Cooking oils and deep fat fires. ✓
	Safe for: Lithium-Ion Battery ✓

CODE: CF-001724V  
Size: 75 X 200 MM

## FLAT PACK TROLLEYS

### OVERVIEW:

Ceasefire Trolleys exemplify functionality by adding manoeuvrability to the location points of the fire safety equipment. It enables easy transportation of the equipment to the fire source aiding efficient firefighting. The trolley has a provision to accommodate up to 2 fire buckets.

### FEATURES:

- Mild steel tubular body.
- Epoxy polyester powder coated internal container lining.
- Nylon wheels with rubber tread for sturdiness & smooth mobility.
- Comes in a box packaging for ease of transit and storage.



### QUICK SPECS:

Single Extinguisher Trolleys	H1100 x L563 x B419 mm   weight - 14.31 kg
Double Extinguisher Trolleys	H1100 x L643 x B419 mm   weight - 15.65 kg
Triple Extinguisher Trolleys	H1100 x L878 x B419 mm   weight - 18.1 kg



## PROVISION FOR ACCESSORIES

The trolleys are equipped with provisions to install fire buckets. The universal mounting bracket makes it easy to use for all extinguisher types, makes, and designs.



## PACKAGING DIMENSIONS



Product	Dimensions
Trolleys for Extinguisher and a Fire Bucket	Size: L-650 x B-430 x H-150 mm
Trolleys for Double Extinguisher and a Fire Bucket	Size: L-660 x B-480 x H-150 mm
Trolleys for Triple Extinguisher and a Two Fire Buckets	Size: L-720 x B-675 x H-150 mm

Scan the QR code to know more about the product



## FLAT PACK FIRE EXTINGUISHER STAND

### OVERVIEW:

Ceasefire's Contractor Stand is a multi-utility fire safety station that stores fire extinguishers, safety signs, evacuation plan, medical kit and an evacuator as per the individual needs of the premises. This being a comprehensive unit carries ample ammunition to provide first line of defence against fire. The stand comes with wheels that make it maneuverable, easy to cart around and can be taken to the point of fire with much ease.

### FEATURES:

- Stand body is built using a round tube made of mild steel.
- Outer body is epoxy polyester powder coated in red .
- The base has plastic wheels with nylon tyres that aids easy mobility.
- Comes in a box packaging for ease of transit and storage.
- The Ceasefire Contractor Stand can accommodate 3 extinguishers, safety signs, manual alarm, and a fire plan.

### QUICK SPECS:

Single Extinguisher Strolley	320 x 290 x 750 mm
Double Extinguisher Strolley	620 x 520 x 1150 mm

Scan the QR code to know more about the product



## MODULAR PLASTIC STAND

### OVERVIEW:

Ceasefire Modular Plastic Stand is designed for both, functional simplicity and aesthetics. This one-universal size floor stand provide a secure and definitive place holder for fire extinguishers at sites. With an easy fix clap this stand can be scaled up to hold single, double and triple extinguishers. Fire Extinguisher signages can be easily fixed on this stand giving a clear visual indication of the type of fire extinguisher it is holding.



## SPECIALLY DESIGNED MOUNTING BRACKET

### OVERVIEW:

A unique feature offered by Ceasefire are specially designed Mounting Brackets to mount the extinguishers on various surfaces in different application areas. These brackets make sure that the extinguishers are not only securely mounted but also ensure no vibration hence keeping them absolutely silent onboard.

### COMPATIBLE SIZES

Available for

1 kg & 2 kg Extinguishers





EXPLORE OUR ADVANCED  
**IN-PANEL & KITCHEN SYSTEMS**  
 PURPOSE-BUILT FOR COMPLETE FIRE RISK ELIMINATION



# TUBE BASED SUPPRESSION SYSTEM FOR SMALL ENCLOSED SPACES

## A GROUND-BREAKING FIREFIGHTING SOLUTION

Considering the need for automatic fire protection, Ceasefire presents an In-Panel Tube Based System for micro enclosed spaces, specifically designed to protect high risk enclosed spaces. This system is driven by a Heat Sensing Tube based fire detection and a mechanical and automatic fire suppression by a localised fire extinguishant available in a stored-pressure form.

The system is designed specially to protect high risk enclosed spaces considering the complexed construction, shape and characteristics of such spaces such as electrical panels, MCB boxes, server racks, CNC machines, etc where the fire risk is randomly distributed inside these spaces and any point inside could become a source of fire due to the complex nature of wirings, integrated circuits, fuses and power connections present inside. A signature component in Ceasefire's In-Panel Tube Based Systems is the specially designed heat-sensitive pneumatic polymer tube. In the event of a fire, the heat-sensitive tube detects an increase in temperature and bursts upon coming into contact with flames, activating the system automatically and extinguishing the fire at the source. The system comes in a host of extinguishing agents like ABC MAP90 Powder, Clean Agent Fluoroketone (FK), Foam in Low Pressure and CO<sub>2</sub> in High Pressure technology, making the system highly versatile and applicable to a large number of spaces.

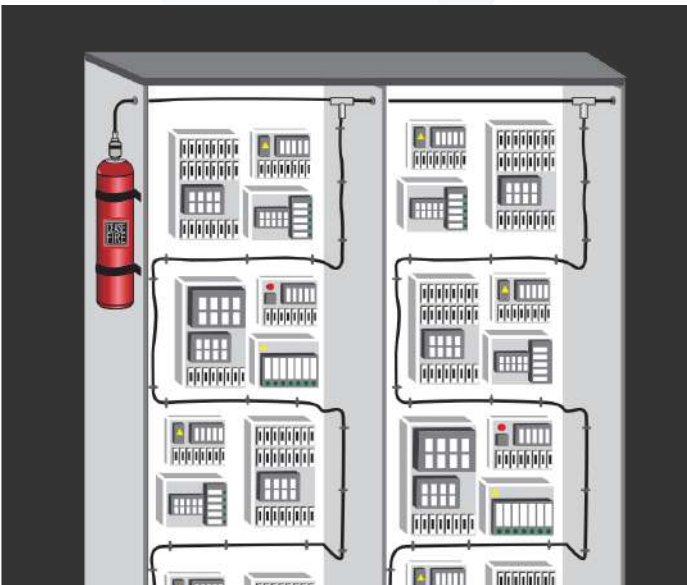

Direct Systems

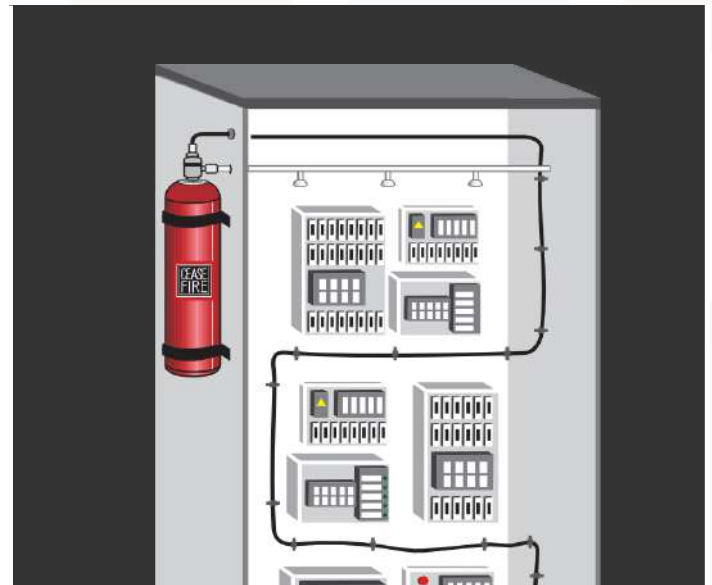

Indirect Systems

The systems are available in both engineered and pre-engineered variants to safeguard every kind of high-risk enclosed environment.

Explore Now



# CEASEFIRE KITCHEN FIRE FIGHTING SYSTEMS

## THE MOST EXTENSIVE RANGE IN THE SEGMENT

Ceasefire today offers an integrated range of kitchen fire suppression systems and fire extinguishers to address the specific needs of quelling cooking oil fires, be it commercial or residential. The range includes LPCB certified Commercial Kitchen Systems with highly advanced heat-sensing tube-based detection in both, Watermist and Wet Chemical agents. These systems are also adapted for home applications in the form of Residential Kitchen Suppression Systems which are tested by BSI and are designed to be completely unobtrusive to not interfere with the decor of your kitchens.

The latest entry in the range includes the Ceasefire UL Listed Commercial Kitchen Fire Suppression System which is specially designed to meet the specific demand from the industry. These systems can be triggered both electrically and mechanically and use a Reech Compliant 100% biodegradable Wet Chemical-based extinguishant.



Ceasefire UL 300 + LPS 1223 + EN 17446 Certified ULtraX Kitchen Suppression System - Wet Chemical



Ceasefire LPCB Certified Commercial Kitchen Suppression System - Wet Chemical / Watermist



Ceasefire BSI Tested Residential Kitchen Suppression System - Wet Chemical / Watermist

Explore Now



# CUSTOMISED SOLUTIONS FOR DIVERSE APPLICATIONS

## AVANT-GARDE TECHNOLOGY FOR MODERN CHALLENGES IN EMERGING SPACES

At Ceasefire we understand every space has its unique fire risks and that is where our bespoke fire solutions come in which are designed exclusively to address the risk of fire in these specific environments. Our specialised solutions are the answer to tackle these modern day fire challenges in a wide variety of spaces and applications.



Vehicle Engines.



Manufacturing Zones.



Wind Turbines.



Office Spaces.



Electrical Panels.



CNC Machines.

Explore Now



# WINNING TRUST WORLDWIDE

Decades of safeguarding lives and protecting assets worldwide with over **3 million Fire Extinguishers** and over **25000 Specialised Fire Suppression Systems** protecting wide range of spaces like Rooms, Kitchens, Electrical Panels, Server Racks, Mobile Towers, Machinery and more for our clients ranging from Start Ups to Unicorns and some of the biggest **global corporate giants**.



and Many More...





# Ceasefire Industries UK Limited

**Registered Office:** Halfords Lane, Smethwick, Birmingham,  
B66 1BU

Tel: 0-113-868-6666 / 0-126-891-9999, E-mail: [response@ceasefire.co.uk](mailto:response@ceasefire.co.uk)



Scan the QR code  
to visit our website

Website : [www.ceasefire.co.uk](http://www.ceasefire.co.uk)

Follow us on:



Please check the product specifications at the time of placing your order. Specifications can change without notice due to our continuous R&D and product improvisation initiatives.

02/04/2026