

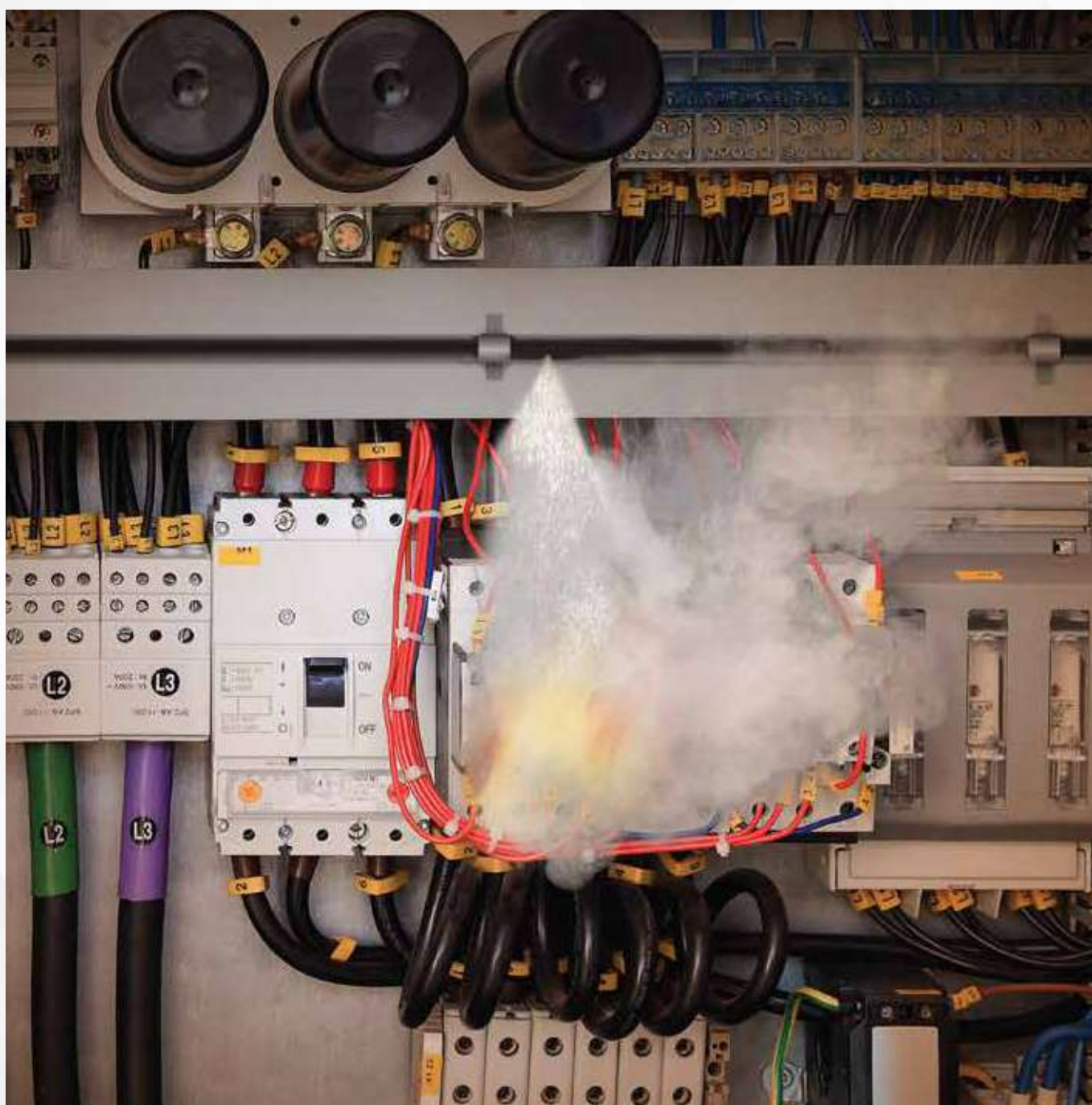

# HOW TO FIGHT A FIRE

## YOU DON'T EVEN KNOW IS THERE



**IN-PANEL TUBE BASED MICRO-ENVIRONMENT  
SUPPRESSION SYSTEM (CQRS)**



LPS 1666  
Cert/LPCB Ref. 1329k

**CEASEFIRE'S IN-PANEL  
TUBE-BASED FIRE  
SUPPRESSION SYSTEM**



# REVOLUTIONARY FIREFIGHTING SOLUTION

Research shows that most fires are electrical. They start with a spark in electrical mains, in the server, in a genset or deep in the engine of an automobile or industrial machinery.

By the time you actually spot the fire and can take action, it's already too late because everything inside has already been destroyed by the fire. Since it goes unnoticed and is often surrounded by

sensitive, flammable material, these are perhaps the most dangerous of all fires. There's just one way to deal with them: instant detection and swift firefighting.

But how do you detect a fire you cannot even see? And even if detected, how do you effectively fight it in an area that is difficult to access?

# IS THERE A WAY TO INSTANTLY DETECT AND COMBAT A BLAZE?

Introducing Ceasefire's Quick Response System, a revolutionary firefighting solution which combines ground-breaking technology with functional simplicity to keep what's precious, safe.

The most prominent feature of the Ceasefire Quick Response System is the specially designed heat-sensitive pneumatic polymer tubing. It is connected at one end to a Ceasefire extinguishing agent container, while the rest of it runs unobtrusively throughout the area at risk. When the flame comes in contact with the heat-sensitive tubing and reaches a temperature of 150° - 180°C, the tubing bursts open at that exact spot and forms a miniature nozzle. The pneumatic mechanism triggers the valve of the extinguisher and sprays the extinguishing agent out of the tube directly onto the flame, dousing the fire instantaneously.

The system comes in a host of extinguishing agents like ABC MAP90 Powder, Fluoroketone (FK), Foam and CO2, making the system highly versatile and applicable for a wide variety of spaces and applications.

The revolutionary technology makes this system entirely self-activated, and requires no human intervention once it has been installed. This makes it especially beneficial for "micro- environments", or areas where the fire hazard is likely to be in an enclosed space (such as a server or a genset).

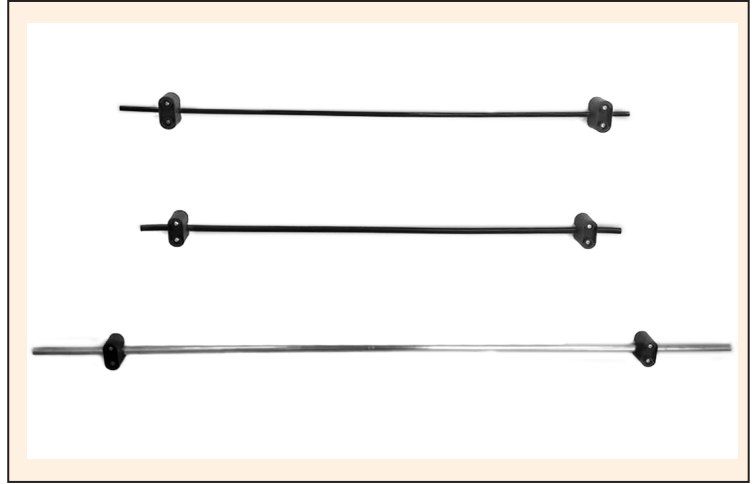

# CUSTOM-MADE SOLUTIONS FOR COMPLETE PEACE OF MIND

In the Direct system, the heat-sensitive tubing acts as an extinguishing agent delivery system. The tube bursts at the point where the fire is detected, forms a miniature nozzle and sprays the extinguishing agent. Ideal for places where fires can break out in localised areas. This is available in low-pressure and high-pressure systems.

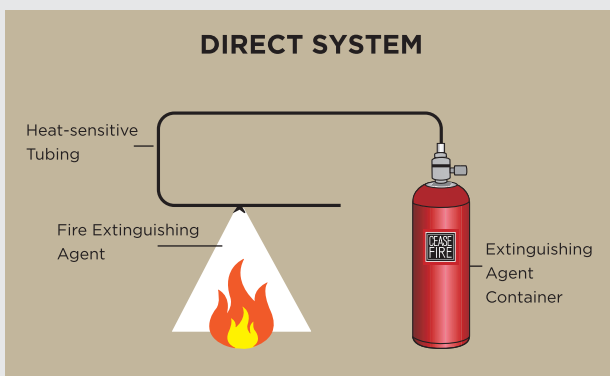

In the Indirect system, the heat-sensitive tubing only acts as a detection device. The extinguishing agent is delivered through a steel conduit and sprayed across the entire area through strategically placed nozzles. Ideal for areas where there is a chance of fires igniting at multiple points. This is available in low-pressure and high-pressure systems.

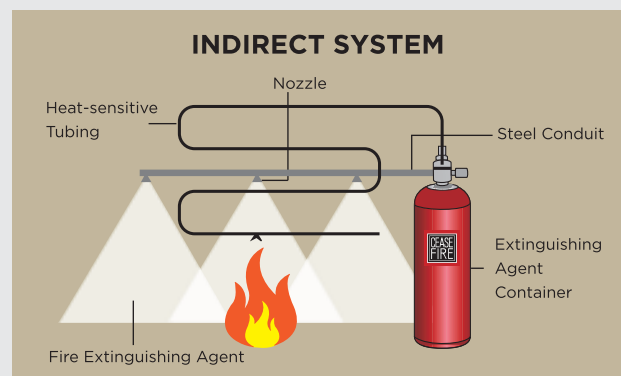

## OVERVIEW OF SOME OF THE FEATURES OF THE CEASEFIRE QUICK RESPONSE SYSTEM:

Fights Class A, B, C and Electrically started fires.

Entirely self-contained, do not require any power supply and will function normally in the event of a power outage.

Instant and automatic activation, eliminating the need for human intervention. The system is in a perpetual state of readiness to combat a fire as soon as it breaks out.

Available in two variants: High Pressure (CO<sub>2</sub> Based) & Low Pressure (Powder, Foam (Fluorine Free) and Clean Agent Based) systems.

Superior extinguishing agents - Fluoroketone (FK), MAP 90 Powder, Foam (Fluorine Free) & CO<sub>2</sub>.

Flexible tubing allows protection in areas that are difficult to access and may not be able to accommodate any other means of detection.

Simple design, and can be installed within a few hours, which means a significant reduction in labour costs and downtime.

Rugged quality ensures it can withstand even harsh conditions where other types of detection systems might be rendered inadequate.

# Direct Systems



# DIRECT SYSTEM

The Ceasefire Direct Quick Response System is ideal for situations in which fires can break out in localised areas. The Direct System is designed by the Ceasefire Design Cell and installed by Ceasefire's expert team after an assessment of the location. Ceasefire's Direct

Quick Response System is available in two variants – Low Pressure and High Pressure. The most suitable option can be installed based on the assessment and requirements of the location.



LPS 1666  
Cert/LPCB Ref. 1329k

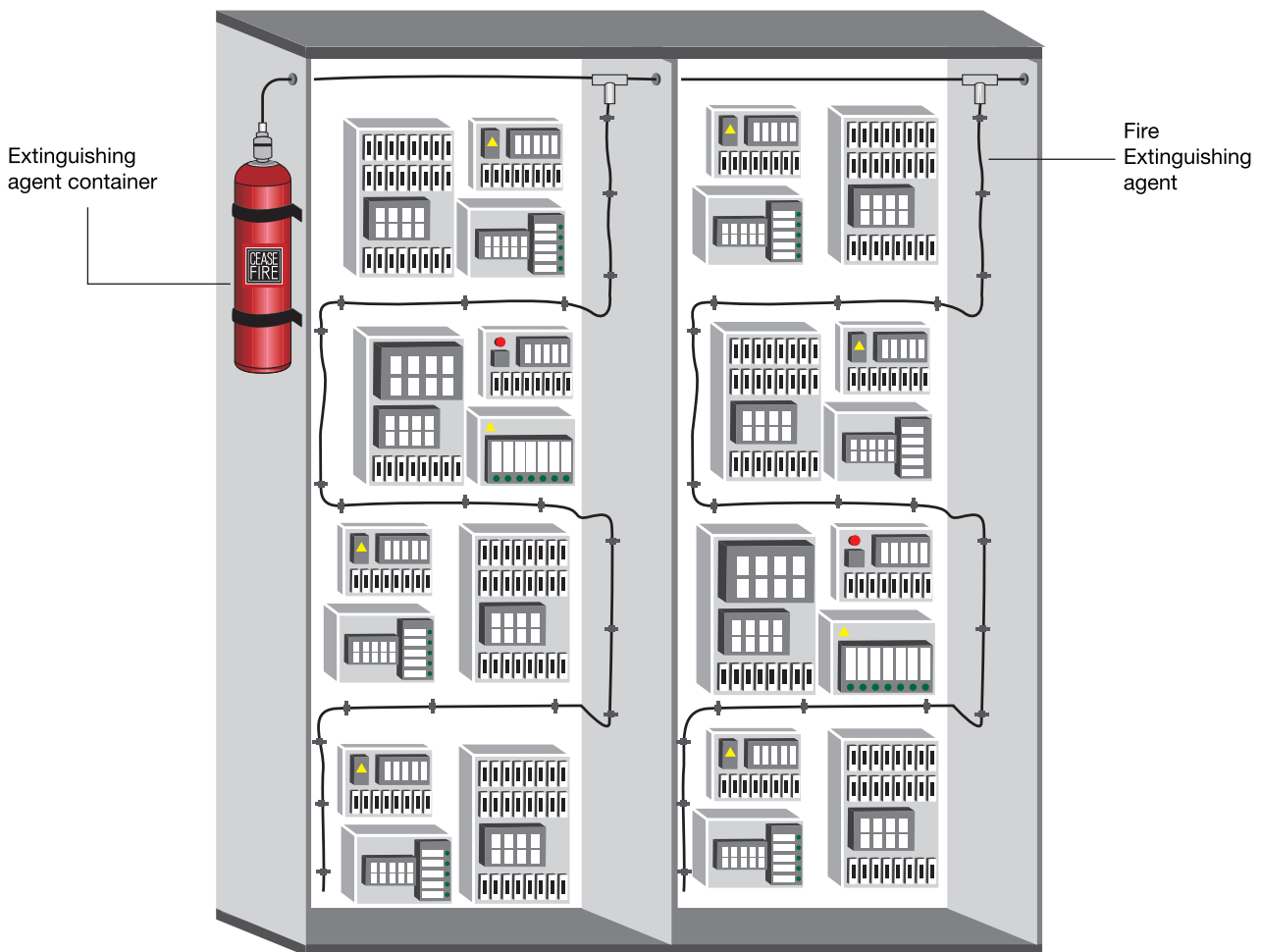

## FUNCTIONING

The single heat-sensitive polymer tube is connected to an extinguishing agent container via a pressure release valve. When a fire breaks out, it results in a drastic increase in temperature. When it reaches 150° - 180°C the heat-sensitive tubing bursts at the point it

is in contact with the flame to form a miniature nozzle. The extinguishing agent is sprayed out of the container and through the mini-nozzle, flooding the localised area and instantly extinguishing the flame.

# ADVANTAGES

The advantages are plain to see. A small fire that breaks out between endless rows of electrical panels may not trigger an alarm until it is much too late. This system, on the other hand, can run intricately and

unobtrusively through Panels, MCBs, Gensets and electrical mains boxes, and is triggered instantly and automatically. This eliminates the need for human intervention and provides a swift and comprehensive solution.



# SYSTEM VARIANTS

Direct Variants				
	Fluoroketone (FK)	CO <sub>2</sub>	ABC Dry Powder	Foam (Fluorine Free)
Direct Low Pressure	NA	NA	1 kg	1 ltr
	NA	NA	2 kg	NA
	3 kg	NA	NA	3 ltr
	4 kg	NA	4 kg	NA
	6 kg	NA	NA	6 ltr
	9 kg	NA	NA	9 ltr
	Direct High Pressure	NA	2 kg	NA
NA		5 kg	NA	NA

# CEASEFIRE DIRECT LOW PRESSURE QUICK RESPONSE SYSTEM

The Ceasefire Direct Low Pressure Quick Response System is an ideal solution in case of fire in a single location, whether small or large. It uses ABC Dry Powder, Foam (Fluorine Free) and Fluoroketone as extinguishing agents.

The Ceasefire Direct Low Pressure Quick Response System can be designed to suit the specific needs of the premises. It comes in an extensive range of variants including 2 kg, 3 kg, 4 kg, 6 kg and 9 kg in Fluoroketone (FK), ABC Dry Powder and Foam (Fluorine Free).



\*Individual SKUs for variants & agents may vary.

# CEASEFIRE DIRECT HIGH PRESSURE QUICK RESPONSE SYSTEM



The Ceasefire Direct High Pressure Quick Response System is a perfect solution in case of fire in a single location, best suited for areas ranging from large to very large in size. This system uses highly pressurised CO<sub>2</sub> as the extinguishing agent.

System is designed to suit the individual needs of the premises, after careful inspection and assessment by the Ceasefire Design Cell and but is available in 2 variants - 2 kg & 5 kg.



# Indirect Systems



# INDIRECT SYSTEM

The Ceasefire Indirect Quick Response System is ideal for locations where there is a chance of ignition of fires at multiple points. For example, in a large electrical cabinet,

where a voltage surge can short-circuit components at multiple locations and cause them to catch fire.

## STRUCTURE AND INSTALLATION

The Indirect System varies structurally from the Direct System. While it retains the pneumatic heat-sensitive tubing, it employs the use of a second conduit made of metal, which acts as a carrier to multiple locations in a room or cabinet, while the pneumatic tube acts only as a sensor. The installation of Ceasefire's Indirect Quick Response System

requires a preliminary assessment by our expert team, using blueprints, photographs and information of the room or cabinet. The Ceasefire Design Cell then puts together a completely customised system based on the assessment of the location.

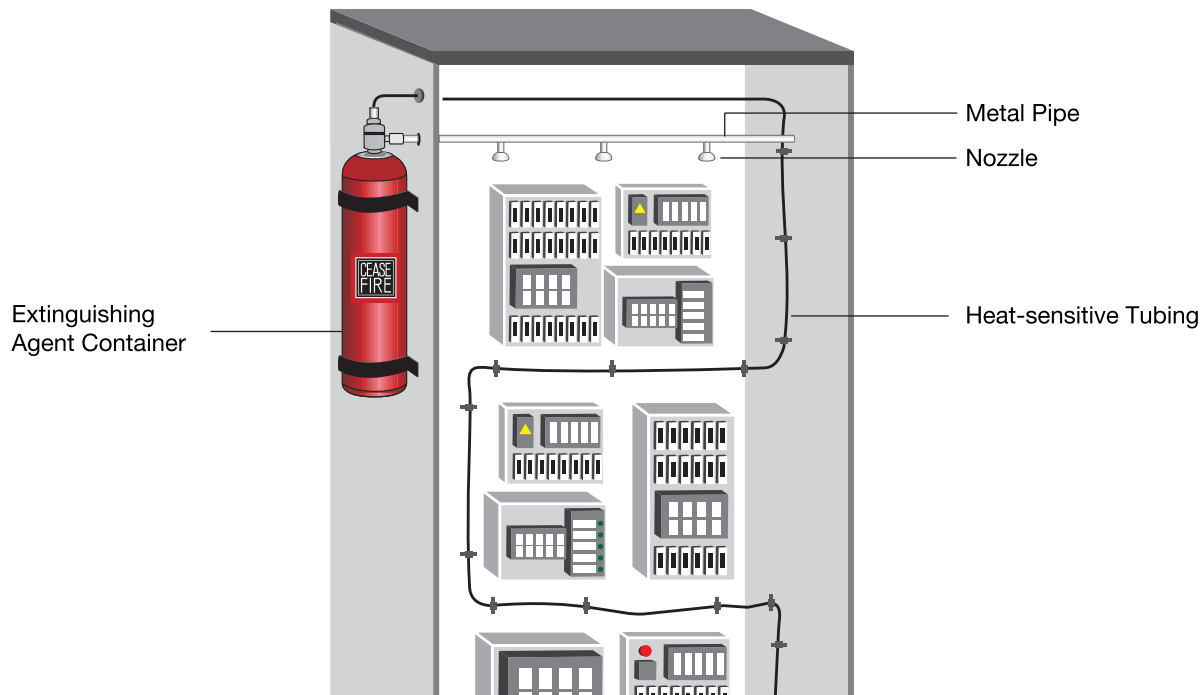

## FUNCTIONING

When a fire breaks out at any location, it is detected by the pneumatic tube and triggers the valve. When the valve opens, extinguishing agent jets out of the

container through the metal conduit, and is sprayed through multiple strategically located nozzles, flooding the micro-environment.

# ADVANTAGES

This instantly puts out any fires that may have broken out in the enclosed area and prevents any further damage.

The primary advantage is that with the Indirect System, fires in multiple locations can be dealt

with instantly and simultaneously. By eliminating the need for human intervention, this system can be vastly useful in preventing large-scale damage while also eliminating the possibility of any flames being reignited.



# SYSTEM VARIANTS

Indirect Variants				
	Fluoroketone (FK)	CO <sub>2</sub>	ABC Dry Powder	Foam (Fluorine Free)
Indirect Low Pressure	2 kg	NA	2 kg	2 ltr
	3 kg	NA	NA	3 ltr
	4 kg	NA	4 kg	NA
	6 kg	NA	6 kg	6 ltr
	9 kg	NA	9 kg	9 ltr
	NA	2 kg	NA	NA
	NA	5 kg	NA	NA
Indirect High Pressure	NA	20 kg	NA	NA

# CEASEFIRE INDIRECT LOW PRESSURE QUICK RESPONSE SYSTEM



The Ceasefire Indirect Low Pressure Quick Response System varies structurally from the Direct Low Pressure Quick Response System, and is ideal for situations where fire could break out in multiple locations at the same time. It uses a host of extinguishing agent to suit any kinds of premises.

The Ceasefire Indirect Low Pressure Quick Response System can be designed to suit the individual needs of a property after careful inspection and assessment by the Ceasefire Design Cell. The system is available in variety of variants 2 kg, 3 kg, 4 kg, 6 kg and 9 kg in Fluoroketone (FK), Foam (Fluorine Free) and ABC Dry Powder to suits the needs of a wide variety of spaces & applications.



\*Individual SKUs for variants & agents may vary.

# CEASEFIRE INDIRECT HIGH PRESSURE QUICK RESPONSE SYSTEM



The Ceasefire Indirect High Pressure Quick Response System varies structurally from the Direct High Pressure Quick Response System, and is ideal for situations where fire could break out in multiple locations at the same time, spread out over a vast extinguishing agent.



The Ceasefire Indirect High Pressure Quick Response System is designed to suit the individual needs of the premises, after careful inspection and assessment by the Ceasefire Design Cell. It is also available over the counter in 3 pre-fabricated variants: 2 kg, 5 kg and 20 kg.



# CONTROL PANEL

Our state-of-the-art Response Panel is designed to monitor up to four-cylinder systems simultaneously, providing comprehensive oversight and control. It features the ability to monitor the status of each system's valves and pressure switches individually. Additionally, it includes a special relay output for the installation of an extra hooter (sound alarm) and lamp flasher (visual indicator) on the detection line, enhancing the alert system.

The panel is equipped with an integrated ball valve, clearly indicating whether the valve is open or closed, ensuring reassurance in the event of accidental opening. It also boasts an inbuilt 24-hour battery backup, ensuring continuous operation during power outages.

For ease of use, the panel includes a user-friendly LCD that clearly spells out any event or problem in case of activation or emergency, making it a reliable and efficient component of your fire safety system.



# THE CEASEFIRE DESIGN CELL

When it comes to saving lives, there is simply no room for compromise. When investing in an exactly what your premises demands. This calls for expert input.

A system as sophisticated as the Ceasefire Quick Response System needs to be designed according to the requirements of the equipment to be protected, keeping in mind all fire hazards that might come into play.

This is where the Ceasefire Design Cell comes in. A team of experts carries out an extensive assessment of the area, identifying the risk

points, with the assistance of blueprints and photographs of the spaces to be protected.

A comprehensive solution is constructed – be it a Direct or Indirect system, whether High Pressure or Low Pressure, exact tube lengths, piping and extinguisher agent containers.

They then install this system to protect what's precious, leaving you with complete peace of mind.

As firefighting technology goes, the Ceasefire Quick Response System is one of the most advanced yet. By automating the process of detection, activation and extinguishing, it provides a comprehensive, highly customised solution to the problem of electrically started fires being detected too late. The Ceasefire Quick Response System is truly a futuristic technology, designed to empower you in the endeavour to protect you and your premises.



## RECOMMENDED USAGE

The Ceasefire Quick Response Systems are ideal for a variety of applications, including:

- Server racks
- Networking / switching racks
- UPS rooms
- Gensets
- CNC machines
- Injection moulding machines
- Printing press
- Diagnostic machines
- Mobile tower switching areas
- Electrical cabinets
- Electrical panels
- Commercial vehicles such as cars, buses and trucks
- Heavy transport vehicles such as airplanes, ships and cargo trucks
- Industrial equipment like forklifts, heavy machinery, gensets and alternators
- Above false ceilings and below false flooring

# CEASEFIRE QUICK RESPONSE SYSTEM



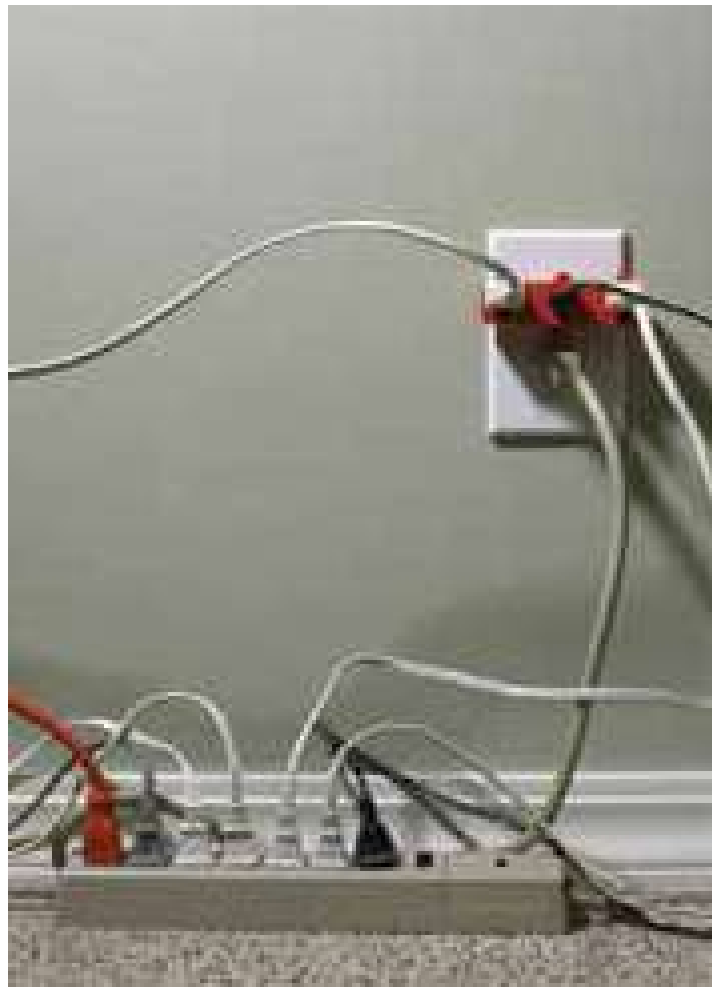

Locations with constantly-running electrical equipment are always prone to fire. Minor short circuits can spark major blazes. It is imperative for these locations to be sufficiently protected against damage from fire.

Typical electrical enclosures include control panels, UPS, transformers/generators, cable trays, power vaults and other similar enclosures with wires and components which can spark a fire at any time. Most of these can be found in practically any industrial or commercial space. These instruments are all susceptible to fire which may occur due to a variety of reasons, ranging from improper installation and wire fatigue to overloaded circuits and equipment failure. Should a fire occur in any of these locations, it could spread rapidly, destroying lives and even the building.

Using Ceasefire's Quick Response System, the fire can be caught at a single location and extinguished before it can spread. It completely avoids the collateral damage that is caused when one uses standard chemical foam extinguishers in these situations. Moreover, because the system utilises a non-damaging, non-corrosive extinguishing agent, there is no significant downtime required to restore the facility to a normal functional level.

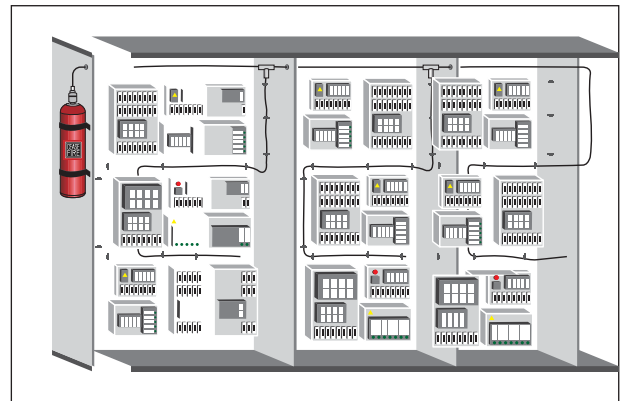

# SERVER AND TELECOMMUNICATION ENCLOSURES



## CEASEFIRE QUICK RESPONSE SYSTEM

A multitude of things we do today is based around computers and the internet. Early-day computers occupied entire rooms. Nowadays, machines are far more powerful to fit into a rack of equipment. In spite of inbuilt cooling fans and ventilation, short circuits and power fluctuation can spark fires that will sweep through a rack, destroying expensive equipment and priceless, irreplaceable data.

For large companies, it could mean massive losses in revenue; and

worse - a massive blow to reputation. Ceasefire's Quick Response System is the complete solution to these problems. Not only will it help extinguish these fires before they cause tremendous amounts of damage, it will also help reduce the time and money taken to clean up and re-establish damaged property. Most importantly, it can save a reputation that's taken years to build.

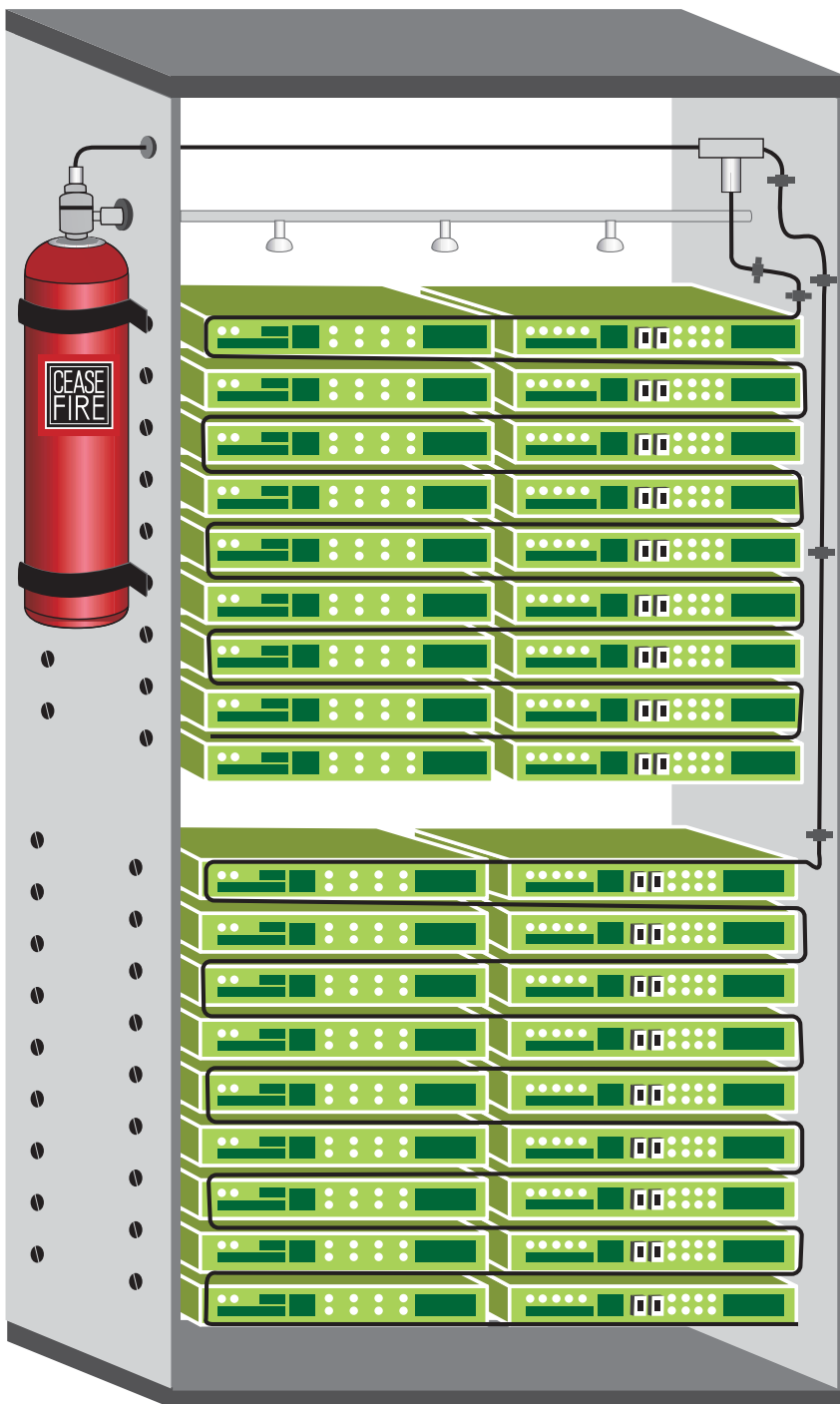



# STRUCTURAL SPACES

Many facilities such as offices and educational institutions use false floors and ceilings to save space and allow for hassle-free wiring. Very often, these wire racks and cable-snakes can overheat due to prolonged usage of equipment and are liable to catch fire. In such an event, it is important to extinguish the fire before it can spread and affect the equipment that these cables are connected to.

Ceasefire's Quick Response System can be installed to run above/under these structures and instantaneously put out any fires that may break out. Detecting fires in these concealed spaces can be difficult, but because the system is fully automated and does not require human intervention, it can put the fire out before it is too late.

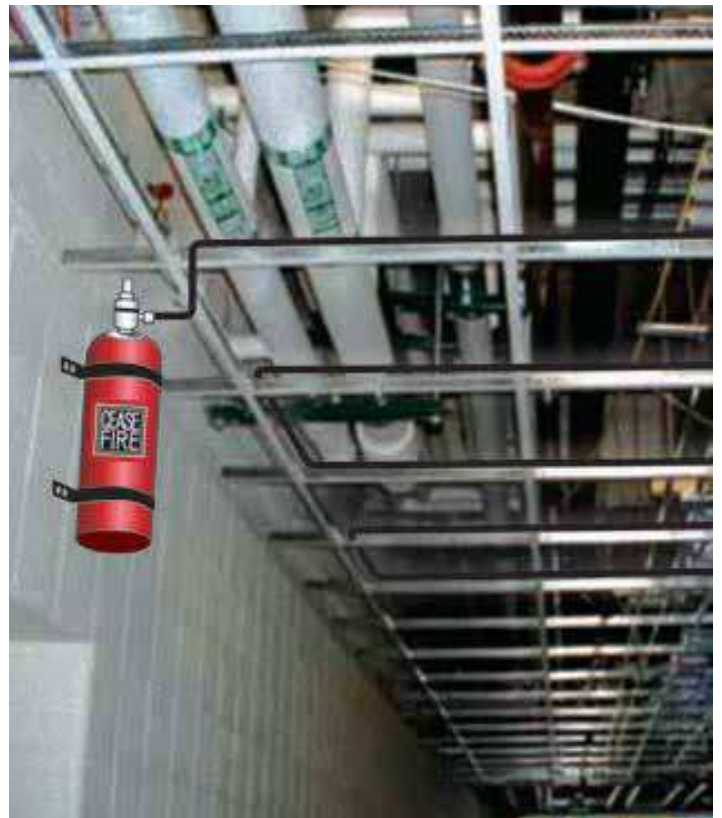

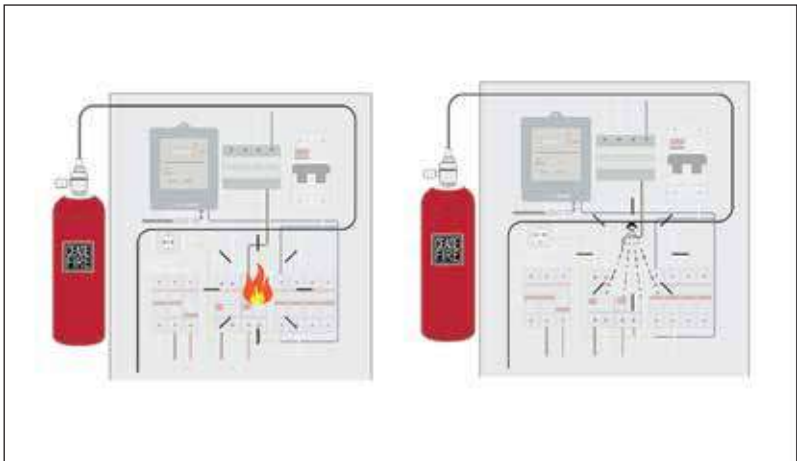

# INDUSTRIAL LOCATIONS

Industries or factories using high- temperature machinery such as CNC machines, injection moulding machines, printing press or diagnostic machines are extremely susceptible to fire. Especially cutting, milling and grinding processes, which make use of oil-based cooling systems.

Even smaller equipment within these factories such as forklifts, generator engines and alternators always run the risk of overheating and sparking a blaze.

An undetected fire in a machine could easily spread to an adjacent one or even into the building's structure through the ducting and wiring. This often results in devastating damage. Using pre-installed sprinkler systems often doesn't do enough to save machinery; worse still, collateral damage can often take a toll far heavier than that of the original fire.

Ceasefire's Quick Response System is ever-vigilant and always ready to spring into action in case of a fire. Should a fire break out, the heat-sensitive pneumatic polymer tubing will detect the hottest point of the blaze and activate the system to douse the flames almost instantaneously.

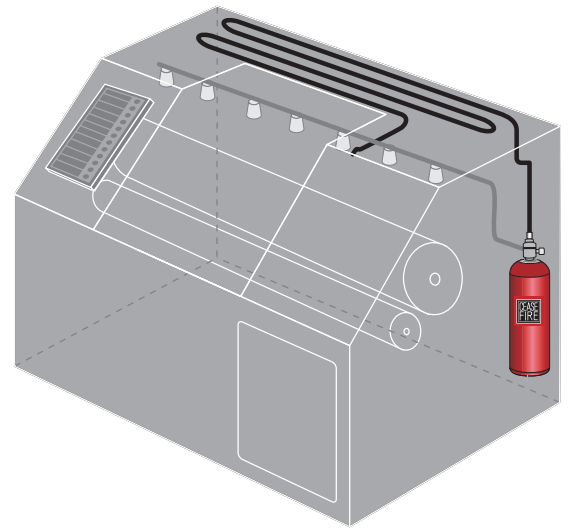

# COMMERCIAL TRANSPORT

We use cars, buses and trains on a daily basis but rarely ever stop to think about the risk we face from fire, even in these vehicles. The impact of fire in any of these public transport systems is tremendous. Most crucially, loss of life.

Using Ceasefire's Quick Response System in vehicles can help instantly detect and extinguish fires. The heat-sensitive polymer tubing is pressurized and bursts due to the heat and radiant energy of a fire, releasing the extinguishing agent. It is a fast, reliable solution and can easily be retro-fitted in vehicles old or new.

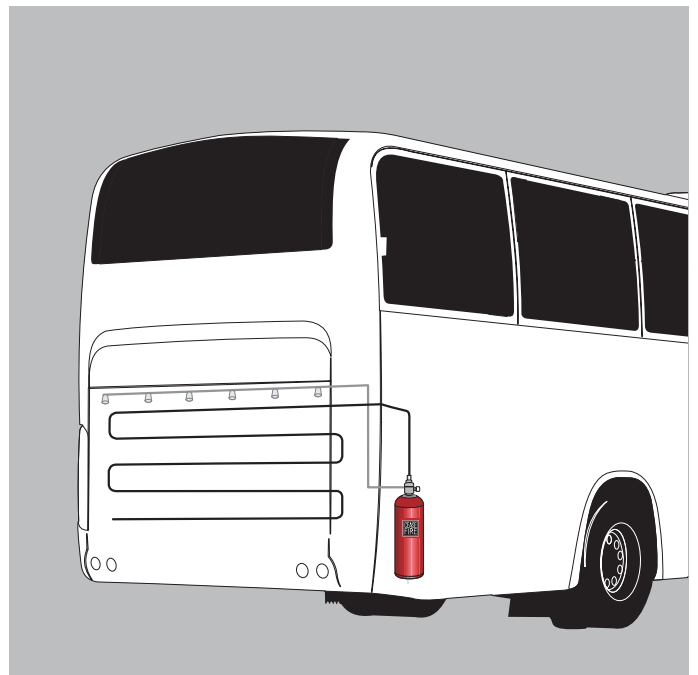
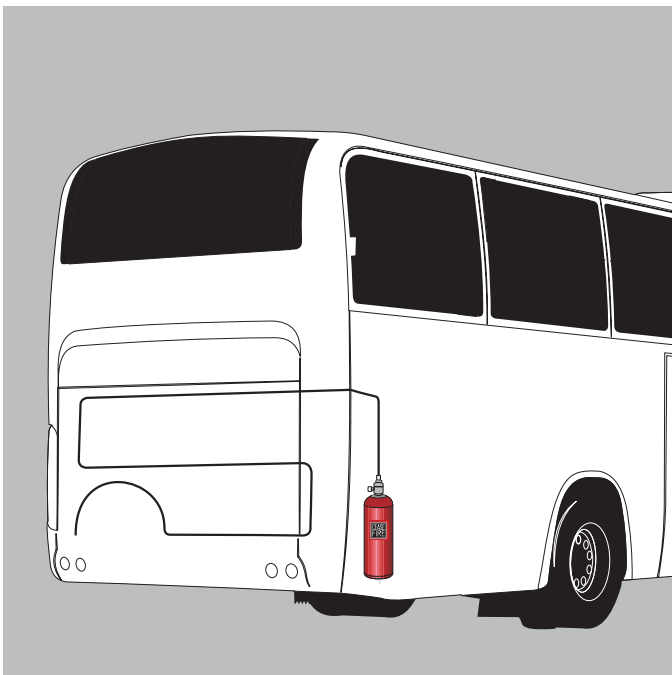
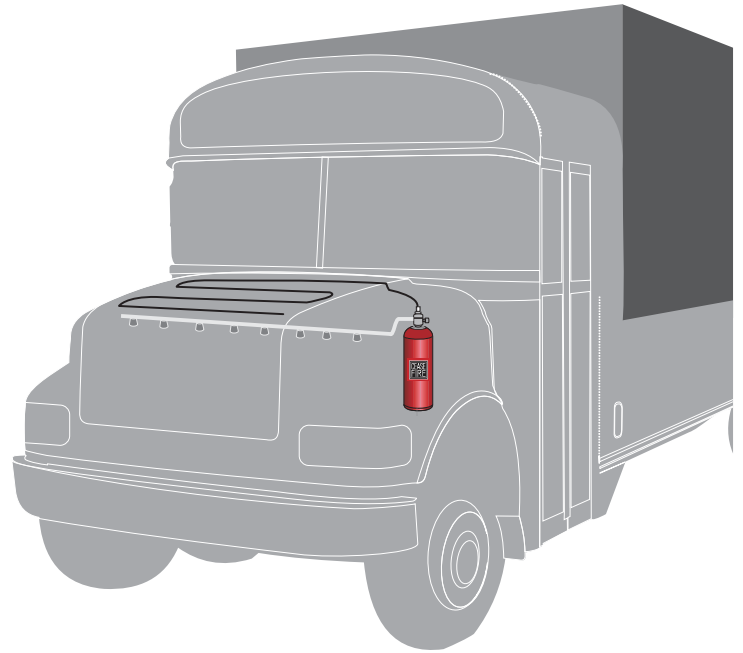

## Ceasefire Industries UK Limited

**Registered Office:** Halfords Lane, Smethwick, Birmingham,  
B66 1BU

Tel: 0-113-868-6666 / 0-126-891-9999, E-mail: [response@ceasefire.co.uk](mailto:response@ceasefire.co.uk)



Scan the QR code  
to visit our website

Website : [www.ceasefire.co.uk](http://www.ceasefire.co.uk)

Follow us on:



Please check the product specifications at the time of placing your order. Specifications can change without notice due to our continuous R&D and product improvisation initiatives.