



THE BIGGEST,

SMALLEST FIREFIGHTER.

CEASEFIRE MINI SUPPRESSION SYSTEM



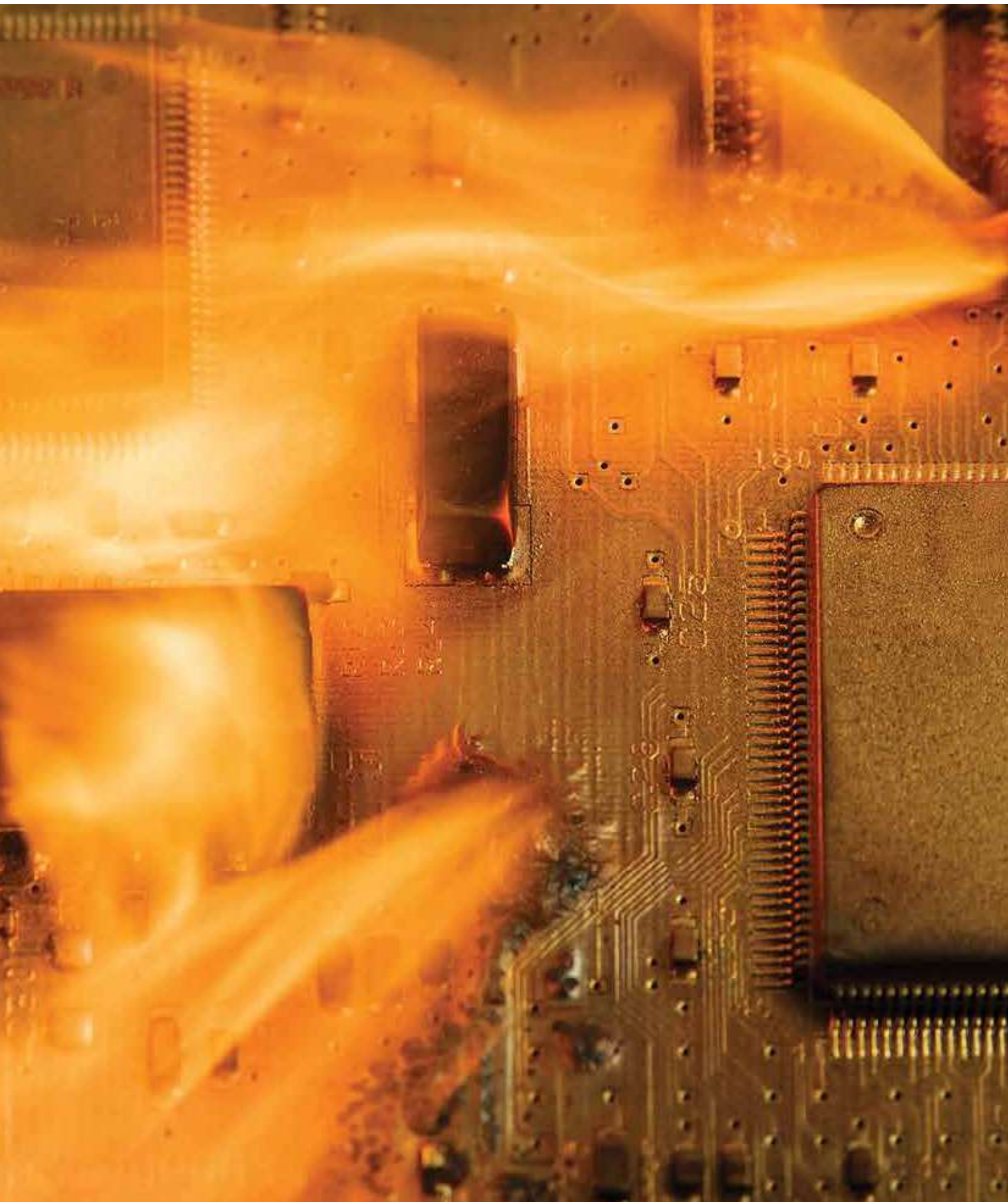



BEHIND EVERY FIRE ARE A FEW USUAL SUSPECTS.

Anyone who's ever been in a fire situation agrees: fire is the biggest foe. Mercilessly ruining everything in its path; be it expensive electronics, mementos or human life. But even the biggest of fires start small, and in an overwhelming majority of cases, experts can trace their origins to tiny enclosed areas, like an electrical cabinet with old wiring or a fuse box.

The only solution is to catch the fire in its nascent stage by guarding these enclosed

areas, so that it doesn't stand a chance of becoming big. Although advanced suppression systems that can detect and kill the fire exist in the market, they are not designed to protect microenvironments like electrical appliances, MCB (Miniature Circuit Breaker) panels or enclosed machinery.

What you need is an ultra-small suppression system that's unobtrusive and can take on a fire the moment it starts.

HELLO, MINI!

Introducing the Ceasefire Mini, the biggest, smallest suppression system in town; and proof that some of the best things do come in small packages.

The Mini is a state-of-the-art microenvironment suppression system designed by Ceasefire. The size of your palm, it sits snugly inside small enclosed spaces that are vulnerable to fire. When the temperature of the micro-environment exceeds a preset limit, the Mini swings into action and automatically extinguishes the fire.

Place it inside your server. Pop it in the fuse box. The Mini fits anywhere, and protects everywhere!

EVOLVED TO PROTECT

At Ceasefire, our products have evolved to take the fight to the fire. First, came simple home extinguishers. Then, complete flooding systems followed by advanced suppression systems. And now, the Mini, the smallest firefighter that takes on a fire the moments it starts.

bsi.
Tested



TYPES OF CEASEFIRE MINI

Ceasefire has designed a Mini to protect practically every kind of micro-environment, including those that cannot be reached by humans.



Mini – Intuitive System

The Mini – Intuitive System is a direct suppression system which protects the micro-environment from inside. Place it inside or attach it to the inner wall of the micro-environment, and the Mini is ready to protect.



Mini – Adaptive System

The Mini – Adaptive System is an indirect suppression system designed for those micro-environments which are too small to even accommodate a Mini, let alone other firefighting systems. In this case, the Mini container is installed outside, with its heat-sensitive glass bulb inside the micro-environment.

COMPONENTS OF THE MINI



Heat-sensitive Glass Bulb:

The Mini's heat-sensitive glass bulb acts as the heat detector. In case the temperature inside the micro-environment rises beyond a preset level, the glass bulb breaks to activate the system. In the Intuitive System, the glass bulb is attached to the main container. While in the Adaptive System, it is attached to a stainless steel barrel which extends from the container.

Ceasefire has specifically designed glass bulbs depending on the temperature conditions of the micro-environment to be protected.

■ In low-temperature settings, like air-conditioned offices, hospitals, server rooms, etc., 57°C is the ideal temperature for electrical cabinets.



Stainless Steel Container:

The Mini's container is a seamless piece of stainless steel that is corrosion resistant. Depending on the amount of extinguishing agent, there are five variants of the Mini container: 100g, 200g, 300g, 400g and 500g.

A ball valve sits on top of the container. This ball valve is available in Intuitive and Adaptive variants.



Stainless Steel Barrel:

The Adaptive System has an option of attaching a stainless steel barrel between the glass bulb and the container to extend the Mini deep into unreachable spots. When the glass bulb breaks, the extinguishing agent passes through the barrel and out of the broken glass bulb.

The barrel is available in three sizes: 100mm, 150mm and 200mm.



Pressure Gauge:

The Mini's state-of-the-art pressure gauge tells you that the extinguishing agent is under optimum pressure and the Mini is in top working condition.





Installation Mounts:

The Ceasefire Mini is attached to the wall of the micro-environment by means of mounts. There are two types of Mini mounts: Standard Installation Mount and Busbar Installation Mount.

FEATURES AND BENEFITS OF CEASEFIRE MINI

- 

Ease of Use:
Being automatic, the Mini requires no prompt to start firefighting.
- 

Fits Anywhere:
The Mini can easily fit into the spots that are most prone to fire.
- 

Electronics-friendly:
The Mini is filled with clean agent that cause no damage to your electronics.
- 

Maintenance-free:
The Mini comes with 5 year warranty and the assurance of no leakage.
- 

Easy to Install with 2 Mounts:
The Standard and Busbar mounts make installation a breeze.
- 

Self-actuation:
Since the Mini is self-actuated, it spots the fire and protects even when no one is around.
- 

No Power Supply Required:
The Mini uses a mechanical release mechanism to start firefighting.
- 

Works on All Classes of Fire:
The Mini can be used on any kind of fire, making it a truly versatile firefighter.
- 

Different temperature settings:
Mini variants are available for 1 heat thresholds : 57°C
- 

Protects all Microenvironments:
Available as an Intuitive or Adaptive System, the Mini protects everywhere.
- 

Heat-sensitive Glass Bulb:
The Mini's glass bulb acts as a heat sensor that detects a rise in surrounding temperature.



TECHNOLOGY MEETS DESIGN IN THE HANDY CEASEFIRE MINI.

Built to protect micro-environments, the Ceasefire Mini automatically kicks into action in a fire situation.

INTUITIVE SYSTEM

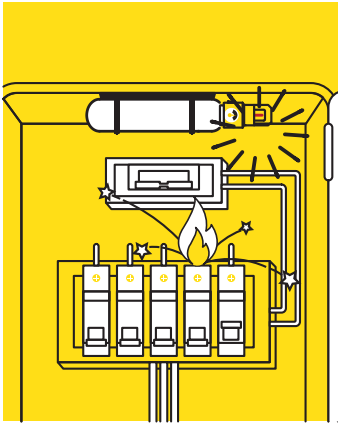

Stage 1:
A fire sparked by a short circuit causes the pressure inside the Mini's glass bulb to increase.

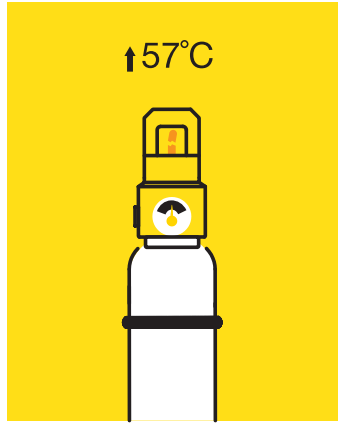

Stage 2:
The very second the temperature rises beyond a point, the bulb breaks and activates the system.

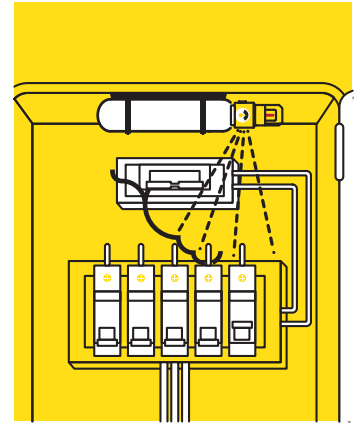

Stage 3:
Instantly, the extinguishing agent is dispersed, killing the fire in its early stages.

ADAPTIVE SYSTEM

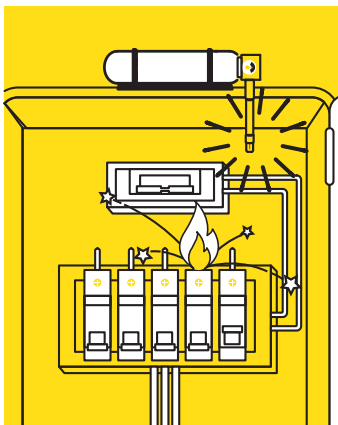

Stage 1:
A fire sparked by a short circuit causes the pressure inside the Mini's glass bulb to increase.

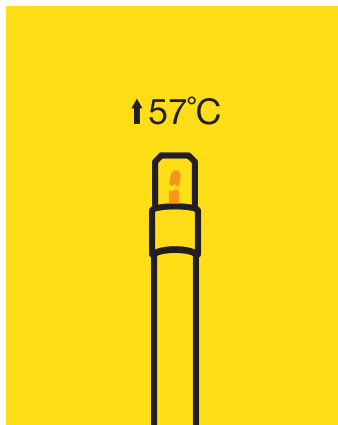

Stage 2:
The very second the temperature rises beyond a point, the bulb breaks and activates the system.

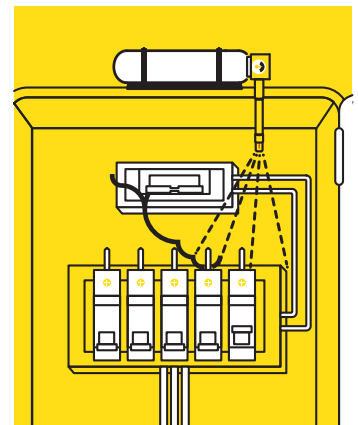

Stage 3:
Instantly, the extinguishing agent is dispersed, killing the fire in its early stages.



The green Ceasefire Mini is available in Fluoroketone (FK). Fluoroketone is a clean agent that causes no collateral damage to your electronics or the Earth, making the Mini absolutely safe.

MINI SUPPRESSION SYSTEM. ZERO HASSLES.

Fitting the Mini is as easy as 1-2-3. It's the only suppression system in the market which can be installed without any help or technical support.

INSTALLING THE MINI - INTUITIVE SYSTEM

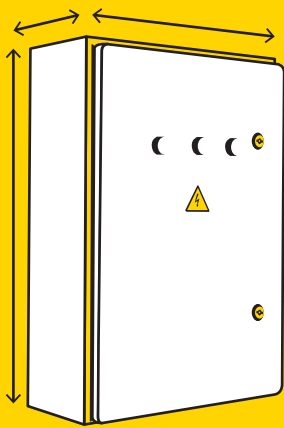

Step 1:
Measure the approximate volume of the enclosure you want to protect.

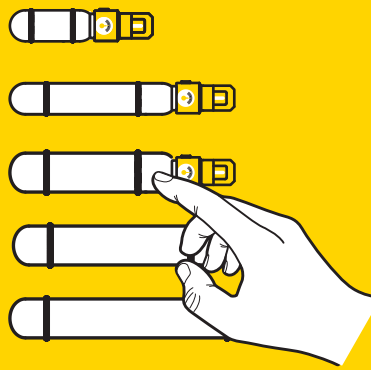

Step 2:
Choose the right variant of the Mini - Intuitive System.

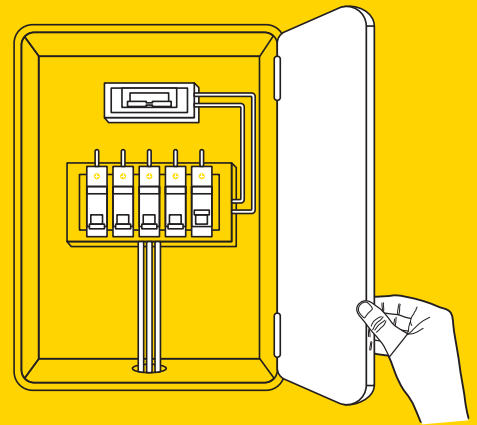

Step 3:
Open your electrical cabinet, AHU or machinery.

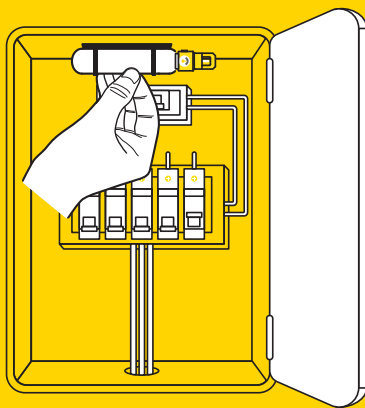

Step 4:
Place the Mini inside, vertically or horizontally. In case of large enclosures, you could screw its bracket to the wall inside and place the Mini on it.

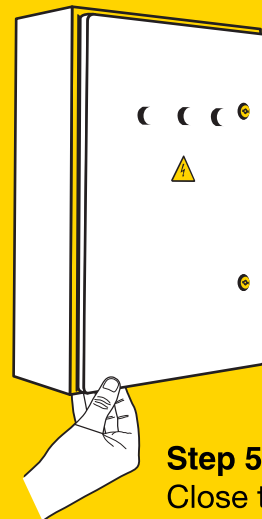

Step 5:
Close the enclosure.

INSTALLING THE MINI - ADAPTIVE SYSTEM

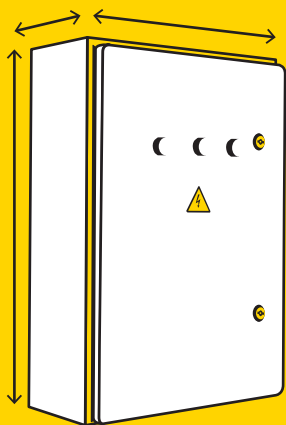

Step 1:
Measure the approximate volume of the enclosure you want to protect.

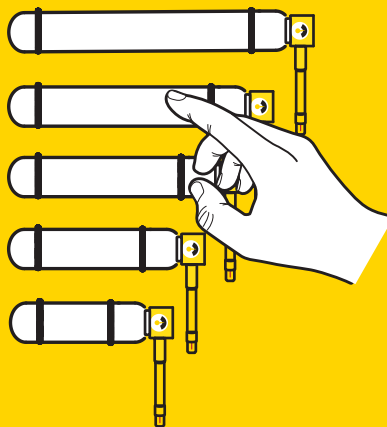

Step 2:
Choose the right variant of the Mini - Adaptive System.

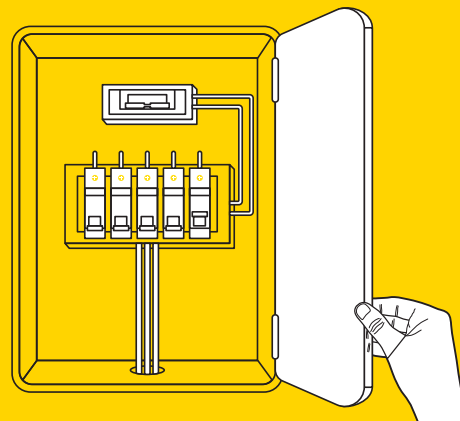

Step 3:
Drill a hole in the wall of your electrical cabinet.

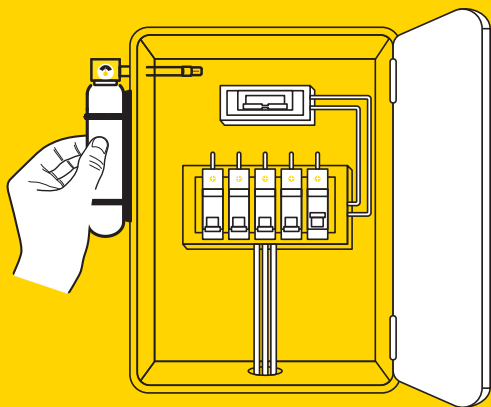

Step 4:
Place the Mini on the outside such that the barrel passes through the hole and the heat-sensing bulb is inside the cabinet.

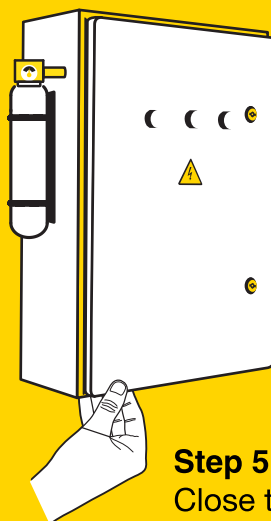

Step 5:
Close the enclosure.

APPLICATION AREAS

The Mini is built to protect electrical cabinets of all kinds in homes, offices, factories, schools and hospitals.



Offices and Data Centres:

With several workstations and computers, some running round-the-clock, offices and data centres are at a high risk of fire. A Mini sitting unobtrusively inside the office's busy electrical cabinet can detect a fire and extinguish it before it destroys your workplace and data. Besides, being powered by clean agent gas, it doesn't cause any discomfort and lets your staff continue working.



Homes:

Electrical cabinets and MCBs (Miniature Circuit Breakers) are blind spots in most houses, as the only time you look at them is when there is no power or when a switch trips. The Mini is built precisely for such an environment. Place it inside the cabinet and forget about it. Whether it's a short circuit or overheating, the Mini will take care of it.



Factories:

Old wiring. Irregular maintenance. A huge consumption of electricity. Electrical cabinets in factories are hotspots of fire, literally. Our tech team will help you determine how many Minis are required to protect the electrical cabinet in your factory so you can stop a fire before it ruins your business.



Schools:

Schools also consume a humungous amount of power, making their electrical cabinets high risk areas. Add to that the responsibility of managing thousands of students and suddenly, it has all the

makings of a major mishap. This is why auto detection of fires is important. And nothing does it better than Minis placed in the electrical cabinets.



Hospitals:

At any point of time, hundreds of patients undergo treatment in a hospital. There are complex scanning machines and labs to test these patients. Put together, all this leads to large power consumption. Minis cut the panic involved in a fire situation by automatically killing fires in the hospital's electrical cabinets.

WHICH MINI VARIANT SHOULD YOU CHOOSE?

If there is a micro-environment in need of protection, you can be sure there is a Mini for it. Depending on the volume of the space you're protecting, Ceasefire has designed 5 variants of the Mini. Here's how you can find the one most suited to your requirements.

MINI 100 Gms



Weight: **100 Gms**
Concentration: **9.5**
Volume in M³: **0.130**

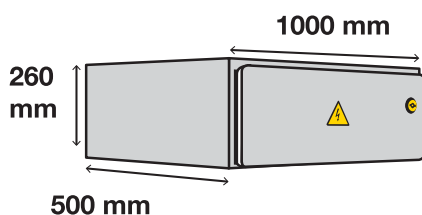

Suitable for sizes with volume ≤ 0.130 M³

Sample Size	Height in mm	Width in mm	Depth in mm
Type 1	260	1000	500
Type 2	380	420	75
Type 3	380	450	75
Type 4	380	495	75
Type 5	380	740	75

MINI 200 Gms



Weight: **200 Gms**
Concentration: **9.5**
Volume in M³: **0.261**

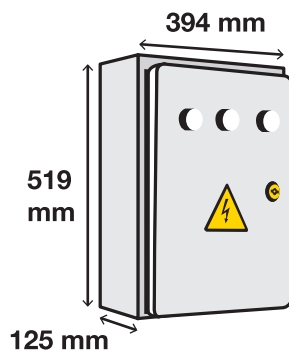

Suitable for sizes with volume ≤ 0.260 M³

Sample Size	Height in mm	Width in mm	Depth in mm
Type 1	520	1000	500
Type 2	519	394	125
Type 3	519	430	125
Type 4	519	466	125
Type 5	519	538	125

MINI 300 Gms



Weight: **300 Gms**
Concentration: **9.5**
Volume in M³: **0.392**

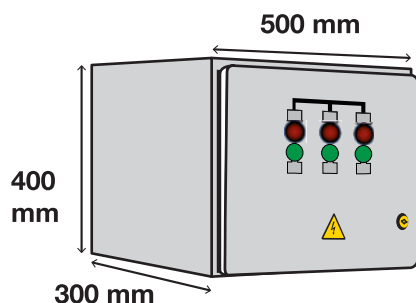

Suitable for sizes with volume ≤ 0.390 M³

Sample Size	Height in mm	Width in mm	Depth in mm
Type 1	780	1000	500
Type 2	400	500	300
Type 3	450	500	300
Type 4	500	500	300
Type 5	550	500	300

MINI 400 Gms



Weight: **400 Gms**
 Concentration: **9.5**
 Volume in M³: **0.520**

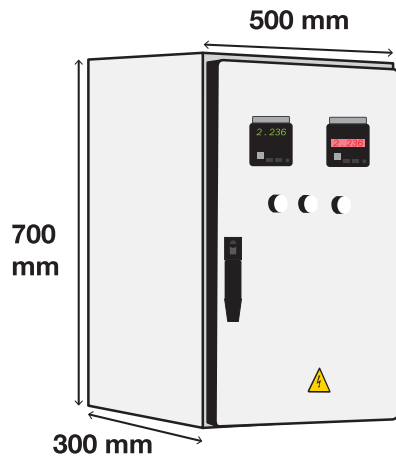

Suitable for sizes with volume ≤ 0.520 M³

Sample Size	Height in mm	Width in mm	Depth in mm
Type 1	380	495	75
Type 2	519	466	125
Type 3	500	500	300
Type 4	700	500	300
Type 5	1250	500	300

MINI 500 Gms



Weight: **500 Gms**
 Concentration: **9.5**
 Volume in M³: **0.780**

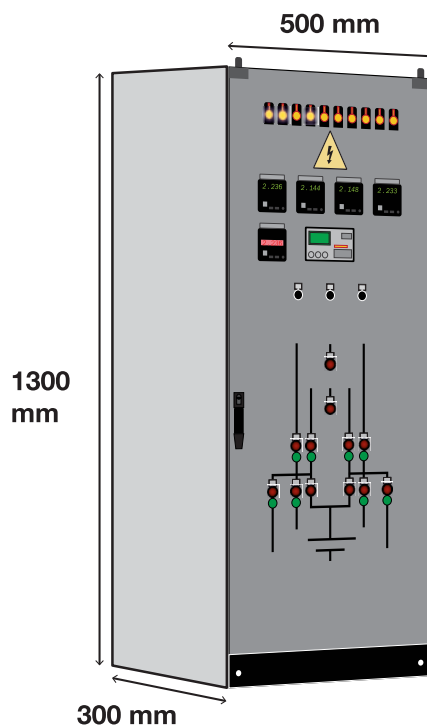

Suitable for sizes with volume ≤ 0.780 M³

Sample Size	Height in mm	Width in mm	Depth in mm
Type 1	1560	1000	500
Type 2	1000	500	300
Type 3	1200	500	300
Type 4	1250	500	300
Type 5	1300	500	300

TECHNICAL SPECIFICATIONS:

Nomenclature	Mini Intuitive 57° C Automatic Fire Ext 100gm SS SP Red	Mini Intuitive 57° C Automatic Fire Ext 200gm SS SP Red	Mini Intuitive 57° C Automatic Fire Ext 300gm SS SP Red	Mini Intuitive 57° C Automatic Fire Ext 400gm SS SP Red	Mini Intuitive 57° C Automatic Fire Ext 500gm SS SP Red
Stored Pressure / Cartridge	Stored Pressure	Stored Pressure	Stored Pressure	Stored Pressure	Stored Pressure
Agent Type	Clean Agent	Clean Agent	Clean Agent	Clean Agent	Clean Agent
Agent	Fluoroketone (FK- 5-1-12)	Fluoroketone (FK- 5-1-12)	Fluoroketone (FK- 5-1-12)	Fluoroketone (FK- 5-1-12)	Fluoroketone (FK- 5-1-12)
Throw	0.5 meters	0.5 meters	0.5 meters	0.5 meters	0.5 meters
Product Code	CF-001339A	CF-001341A	CF-001343A	CF-001345A	CF-001347A
Certification type	PED BSI TESTED**	PED BSI TESTED**	PED BSI TESTED**	PED BSI TESTED**	PED BSI TESTED**
PED	YES	YES	YES	YES	YES
MED	NO	NO	NO	NO	NO
Gross Weight (approx.)	0.665 Kg	0.90 kg	1.10 Kg	1.25 Kg	1.45 Kg
Net Mass (approx.)	100 Gm	200 Gm	300 Gm	400 Gm	500 Gm
Maximum Volume Covered	0.130 m ³	0.260 m ³	0.290 m ³	0.520 m ³	0.653 m ³
Total Height of Fire Ext. (approx.)	184 mm	284 mm	276 mm	331 mm	386 mm
Discharge Mechanism	Automatic QBD*	Automatic QBD*	Automatic QBD*	Automatic QBD*	Automatic QBD*
Applicable On Fires	A, B, C & Electrical Started Fire	A, B, C & Electrical Started Fire	A, B, C & Electrical Started Fire	A, B, C & Electrical Started Fire	A, B, C & Electrical Started Fire
Can Construction	DEEP DRAWN AND MIG WELDED	DEEP DRAWN AND MIG WELDED	DEEP DRAWN AND MIG WELDED	DEEP DRAWN AND MIG WELDED	DEEP DRAWN AND MIG WELDED
Valve / Cap Construction	MACHINING	MACHINING	MACHINING	MACHINING	MACHINING
External Coating	EPOXY POLYESTER POWDER	EPOXY POLYESTER POWDER	EPOXY POLYESTER POWDER	EPOXY POLYESTER POWDER	EPOXY POLYESTER POWDER
Warranty In Years	5	5	5	5	5
G.A. Drawing Number	CF/SP-CA100-VR/GA/01	CF/SP-CA200-VR/GA/01	CF/SP-CA300-VR/GA/01	CF/SP-CA400-VR/GA/01	CF/SP-CA500-VR/GA/01
Working Pressure	10 / 12 Bar	10 / 12 Bar	10 / 12 Bar	10 / 12 Bar	10 / 12 Bar
Dia. Of Shell (OD)	40.0 mm	40.0 mm	50.0 mm	50.0 mm	50.0 mm
Hydrostatic Test Pressure	35Bar	35Bar	35Bar	35Bar	35Bar
Cylinder Material Spec.	SS 316L (1.4435)	SS 316L (1.4435)	SS 316L (1.4435)	SS 316L (1.4435)	SS 316L (1.4435)
Body Thickness	1.2 mm	1.2 mm	1.2 mm	1.2 mm	1.2 mm

**Test Completed, Report Awaited.

Please check the product specifications at the time of placing your order from our website (address of which is given at the end of this catalogue). Specifications can change without notice due to our continuous R&D and product improvisation initiatives.

*QUARTZOID BULB KEY

● 57°C / 135°F

● 68°C / 155°F

● 79°C / 174°F

● 93°C / 200°F

● 141°C / 286°F

● 182°C / 360°F

● 227°C / 440°F

TECHNICAL SPECIFICATIONS:

Nomenclature	Mini Adaptive 57°C Automatic Fire Ext 100 SS SP Red with 50mm barrel	Mini Adaptive 57°C Automatic Fire Ext 100 SS SP Red with 100mm barrel	Mini Adaptive 57°C Automatic Fire Ext 100 SS SP Red with 200mm barrel	Mini Adaptive 57°C Automatic Fire Ext 200 SS SP Red with 50mm barrel	Mini Adaptive 57°C Automatic Fire Ext 200 SS SP Red with 100mm barrel
Stored Pressure / Cartridge	Stored Pressure	Stored Pressure	Stored Pressure	Stored Pressure	Stored Pressure
Agent Type	Clean Agent	Clean Agent	Clean Agent	Clean Agent	Clean Agent
Agent	Fluoroketone (FK- 5-1-12)	Fluoroketone (FK- 5-1-12)	Fluoroketone (FK- 5-1-12)	Fluoroketone (FK- 5-1-12)	Fluoroketone (FK- 5-1-12)
Throw	0.5 meters	0.5 meters	0.5 meters	0.5 meters	0.5 meters
Product Code	CF-001340AA	CF-001340AB	CF-001340AC	CF-001342AA	CF-001342AB
Certification type	PED BSI TESTED**	PED BSI TESTED**	PED BSI TESTED**	PED BSI TESTED**	PED BSI TESTED**
PED	YES	YES	YES	YES	YES
MED	NO	NO	NO	NO	NO
Gross Weight (approx.)	0.695 Kg	0.738 Kg	0.822 Kg	0.935 kg	0.970 Kg
Net Mass (approx.)	100 Gm	100 Gm	100 Gm	200 Gm	200 Gm
Maximum Volume Covered	0.130 m ³	0.130 m ³	0.130 m ³	0.260 m ³	0.260 m ³
Total Height of Fire Ext. (approx.)	148 mm	148 mm	148 mm	248 mm	248 mm
Discharge Mechanism	Automatic QBD*	Automatic QBD*	Automatic QBD*	Automatic QBD*	Automatic QBD*
Applicable On Fires	A, B, C & Electrical Started Fire	A, B, C & Electrical Started Fire	A, B, C & Electrical Started Fire	A, B, C & Electrical Started Fire	A, B, C & Electrical Started Fire
Can Construction	DEEP DRAWN AND MIG WELDED	DEEP DRAWN AND MIG WELDED	DEEP DRAWN AND MIG WELDED	DEEP DRAWN AND MIG WELDED	DEEP DRAWN AND MIG WELDED
Valve / Cap Construction	MACHINING	MACHINING	MACHINING	MACHINING	MACHINING
Internal Coating	NO	NO	NO	NO	NO
External Coating	EPOXY POLYESTER POWDER	EPOXY POLYESTER POWDER	EPOXY POLYESTER POWDER	EPOXY POLYESTER POWDER	EPOXY POLYESTER POWDER
Warranty In Years	5	5	5	5	5
Working Pressure	10 / 12 Bar	10 / 12 Bar	10 / 12 Bar	10 / 12 Bar	10 / 12 Bar
Dia. Of Shell (OD)	40 mm	40 mm	40 mm	50 mm	50 mm
Hydrostatic Test Pressure	35 Bar	35 Bar	35 Bar	35 Bar	35 Bar
Cylinder Material Spec.	SS 316L (1.4435)	SS 316L (1.4435)	SS 316L (1.4435)	SS 316L (1.4435)	SS 316L (1.4435)
Body Thickness	1.2 mm	1.2 mm	1.2 mm	1.2 mm	1.2 mm

**Test Completed, Report Awaited.

Please check the product specifications at the time of placing your order from our website (address of which is given at the end of this catalogue). Specifications can change without notice due to our continuous R&D and product improvisation initiatives.

*QUARTZOID BULB KEY

● 57°C / 135°F

● 68°C / 155°F

● 79°C / 174°F

● 93°C / 200°F

● 141°C / 286°F

● 182°C / 360°F

● 227°C / 440°F

TECHNICAL SPECIFICATIONS:

Nomenclature	Mini Adaptive 57°C Automatic Fire Ext 200 SS SP Red with 200mm barrel	Mini Adaptive 57°C Automatic Fire Ext 300 SS SP Red with 50mm barrel	Mini Adaptive 57°C Automatic Fire Ext 300 SS SP Red with 100mm barrel	Mini Adaptive 57°C Automatic Fire Ext 300 SS SP Red with 200mm barrel	Mini Adaptive 57°C Automatic Fire Ext 400 SS SP Red with 50mm barrel
Stored Pressure / Cartridge	Stored Pressure	Stored Pressure	Stored Pressure	Stored Pressure	Stored Pressure
Agent Type	Clean Agent	Clean Agent	Clean Agent	Clean Agent	Clean Agent
Agent	Fluoroketone (FK- 5-1-12)	Fluoroketone (FK- 5-1-12)	Fluoroketone (FK- 5-1-12)	Fluoroketone (FK- 5-1-12)	Fluoroketone (FK- 5-1-12)
Throw	0.5 meters	0.5 meters	0.5 meters	0.5 meters	0.5 meters
Product Code	CF-001342AC	CF-001344AA	CF-001344AB	CF-001344AC	CF-001346AA
Certification	PED BSI TESTED**	PED BSI TESTED**	PED BSI TESTED**	PED BSI TESTED**	PED BSI TESTED**
Gross Weight (approx.)	1.05 Kg	1.07 Kg	1.12 Kg	1.20 Kg	1.27 Kg
Net Mass (approx.)	200 Gm	300 Gm	300 Gm	300 Gm	400 Gm
Maximum Volume Covered	0.260 m ³	0.290 m ³	0.290 m ³	0.290 m ³	0.520 m ³
Total Height of Fire Ext. (approx.)	248 mm	240 mm	240 mm	240 mm	295 mm
Discharge Mechanism	Automatic QBD*	Automatic QBD*	Automatic QBD*	Automatic QBD*	Automatic QBD*
Applicable On Fires	A, B, C & Electrical Started Fire	A, B, C & Electrical Started Fire	A, B, C & Electrical Started Fire	A, B, C & Electrical Started Fire	A, B, C & Electrical Started Fire
Can Construction	DEEP DRAWN AND MIG WELDED	DEEP DRAWN AND MIG WELDED	DEEP DRAWN AND MIG WELDED	DEEP DRAWN AND MIG WELDED	DEEP DRAWN AND MIG WELDED
Valve / Cap Construction	MACHINING	MACHINING	MACHINING	MACHINING	MACHINING
Internal Coating	NO	NO	NO	NO	NO
External Coating	EPOXY POLYESTER POWDER	EPOXY POLYESTER POWDER	EPOXY POLYESTER POWDER	EPOXY POLYESTER POWDER	EPOXY POLYESTER POWDER
Warranty In Years	5	5	5	5	5
Working Pressure	10 / 12 Bar	10 / 12 Bar	10 / 12 Bar	10 / 12 Bar	10 / 12 Bar
Dia. Of Shell (OD)	40 mm	50 mm	50 mm	50 mm	50 mm
Hydrostatic Test Pressure	35 Bar	35 Bar	35 Bar	35 Bar	35 Bar
Cylinder Material Spec.	SS 316L (1.4435)	SS 316L (1.4435)	SS 316L (1.4435)	SS 316L (1.4435)	SS 316L (1.4435)
Body Thickness	1.2 mm	1.2 mm	1.2 mm	1.2 mm	1.2 mm

**Test Completed, Report Awaited.

Please check the product specifications at the time of placing your order from our website (address of which is given at the end of this catalogue). Specifications can change without notice due to our continuous R&D and product improvisation initiatives.

*QUARTZOID BULB KEY

● 57°C / 135°F

● 68°C / 155°F

● 79°C / 174°F

● 93°C / 200°F

● 141°C / 286°F

● 182°C / 360°F

● 227°C / 440°F

TECHNICAL SPECIFICATIONS:

Nomenclature	Mini Adaptive 57°C Automatic Fire Ext 400 SS SP Red with 100mm barrel	Mini Adaptive 57°C Automatic Fire Ext 400 SS SP Red with 200mm barrel	Mini Adaptive 57°C Automatic Fire Ext 500 SS SP Red with 50mm barrel	Mini Adaptive 57°C Automatic Fire Ext 500 SS SP Red with 100mm barrel	Mini Adaptive 57°C Automatic Fire Ext 500 SS SP Red with 200mm barrel
Stored Pressure / Cartridge	Stored Pressure	Stored Pressure	Stored Pressure	Stored Pressure	Stored Pressure
Agent Type	Clean Agent	Clean Agent	Clean Agent	Clean Agent	Clean Agent
Agent	Fluoroketone (FK- 5-1-12)	Fluoroketone (FK- 5-1-12)	Fluoroketone (FK- 5-1-12)	Fluoroketone (FK- 5-1-12)	Fluoroketone (FK- 5-1-12)
Throw	0.5 meters	0.5 meters	0.5 meters	0.5 meters	0.5 meters
Product Code	CF-001346AB	CF-001346AC	CF-001348AA	CF-001348AB	CF-001348AC
Certification type	PED BSI TESTED**	PED BSI TESTED**	PED BSI TESTED**	PED BSI TESTED**	PED BSI TESTED**
Gross Weight (approx.)	1.30 Kg	1.39 Kg	1.46 Kg	1.50 Kg	1.58 Kg
Net Mass (approx.)	400 Gm	400 Gm	500 Gm	500 Gm	500 Gm
Maximum Volume Covered	0.520 m ³	0.520 m ³	0.650 m ³	0.650 m ³	0.650 m ³
Total Height of Fire Ext. (approx.)	295 mm	295 mm	350 mm	350 mm	350 mm
Discharge Mechanism	Automatic QBD*	Automatic QBD*	Automatic QBD*	Automatic QBD*	Automatic QBD*
Applicable On Fires	A, B, C & Electrical Started Fire	A, B, C & Electrical Started Fire	A, B, C & Electrical Started Fire	A, B, C & Electrical Started Fire	A, B, C & Electrical Started Fire
Can Construction	DEEP DRAWN AND MIG WELDED	DEEP DRAWN AND MIG WELDED	DEEP DRAWN AND MIG WELDED	DEEP DRAWN AND MIG WELDED	DEEP DRAWN AND MIG WELDED
Valve / Cap Construction	MACHINING	MACHINING	MACHINING	MACHINING	MACHINING
Internal Coating	NO	NO	NO	NO	NO
External Coating	EPOXY POLYESTER POWDER	EPOXY POLYESTER POWDER	EPOXY POLYESTER POWDER	EPOXY POLYESTER POWDER	EPOXY POLYESTER POWDER
Warranty In Years	5	5	5	5	5
Working Pressure	10 / 12 Bar	10 / 12 Bar	10 / 12 Bar	10 / 12 Bar	10 / 12 Bar
Dia. Of Shell (OD)	50 mm	50 mm	50 mm	50 mm	50 mm
Hydrostatic Test Pressure	35 Bar	35 Bar	35 Bar	35 Bar	35 Bar
Cylinder Material Spec.	SS 316L (1.4435)	SS 316L (1.4435)	SS 316L (1.4435)	SS 316L (1.4435)	SS 316L (1.4435)
Body Thickness	1.2 mm	1.2 mm	1.2 mm	1.2 mm	1.2 mm

**Test Completed, Report Awaited.

Please check the product specifications at the time of placing your order from our website (address of which is given at the end of this catalogue). Specifications can change without notice due to our continuous R&D and product improvisation initiatives.

*QUARTZOID BULB KEY

● 57°C / 135°F

● 68°C / 155°F

● 79°C / 174°F

● 93°C / 200°F

● 141°C / 286°F

● 182°C / 360°F

● 227°C / 440°F



Ceasefire Industries UK Limited

Office Number 301.3 One Victoria Square, Birmingham
West Midlands B1 1BD, United Kingdom

Tel: 0-113-868-6666 / 0-126-891-9999



Scan the QR code
to visit our website

Website : www.ceasefire.co.uk

Follow us on:



TO PLACE AN ORDER, PLEASE CONTACT: